

Principles of Potato Storage

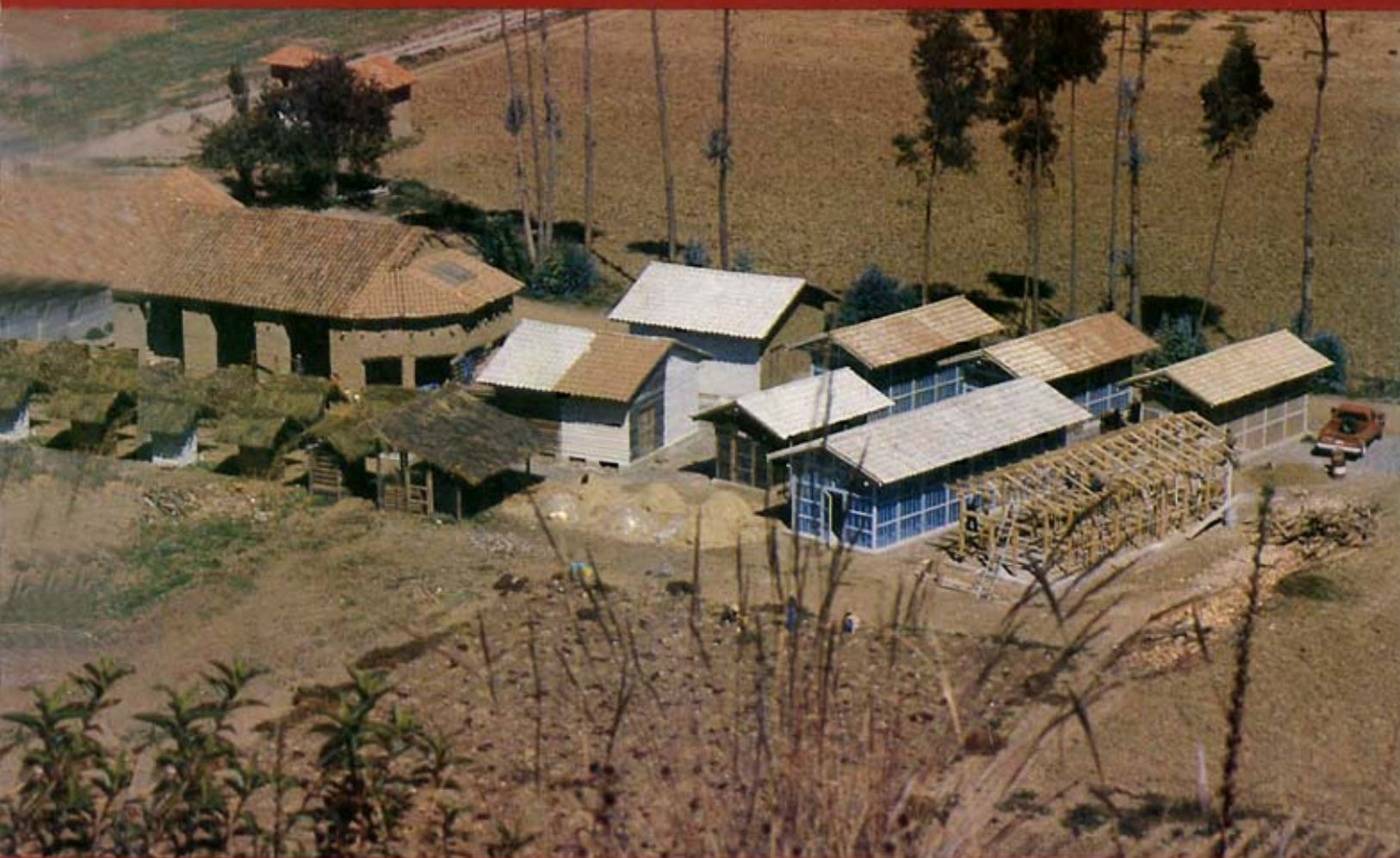

INTERNATIONAL POTATO CENTER (CIP)

P. O. Box 5969 Lima - Peru, Cables: CIPAPA - Lima.
Telex: 25672 PE. Telephones: 354283 - 354354 - 366920

CIP
Centro Internacional de la Papa



CIP S8 B66.2

CIP
S8
B66.2

PRINCIPLES OF POTATO STORAGE

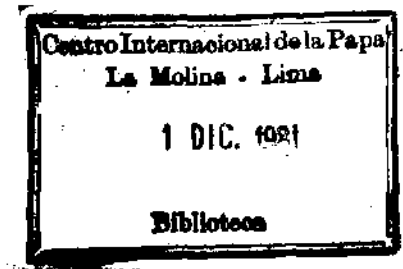

by

Robert H. Booth

and

Roy L. Shaw

of the

International Potato Center
Apartado 5969
Lima, Peru

004124

2-12-81

4124



FOREWORD

This manual combines practical scientific and engineering information with the authors' potato storage experiences in many countries. Its purpose is to help scientists and technologists understand and solve potato storage problems. This publication therefore considers some important socio-economic factors in addition to essential biological and engineering considerations. Basic storage principles appropriate to a wide range of storage needs under different circumstances are outlined and discussed.

The International Potato Center (CIP) is an autonomous non-profit scientific institution established through agreement with the Government of Peru for the purpose of developing and disseminating knowledge for greater use of the potato as a basic food. International funding sources for technical assistance in agriculture finance the Center.

COVER--The International Potato Center's storage research and training complex at Huancayo, Peru.

ACKNOWLEDGMENTS

The authors thank the staff of the International Potato Center (CIP) for assistance in preparation and production of this manual. Major sources of literature referred to during the preparation of the publication include: (1) British Potato Marketing Board, Sutton Bridge Experimental Station Reports; (2) *The Potato*, by W. G. Burton, publ. H. Veenman and Zonen N. V., Wageningen, Holland; and (3) *The Potato Storage*, edited by B. F. Cargill, publ. Michigan State University, USA. Permission to use the psychrometric charts was granted by the Carrier Corporation, Syracuse, New York.

CONTENTS

	Page
1 INTRODUCTION	1
The Storage System	3
2 STORAGE NEEDS	5
3 THE POTATO	13
Potato Tubers	15
Post-harvest Losses	15
Physical factors	15
Physiological losses	16
Pathogenic losses	19
Methods of Loss Reduction and Control	20
4 STORAGE METHODS	25
Introduction	27
Choice of Storage Methods	27
Alternative Storage Methods	29
Delayed harvest	29
Clamps	29
Multipurpose and Adapted Buildings	30
Purposely Constructed Potato Stores	31
Seed Storage Methods	31
Improving Storage Methods	37
5 STORAGE ENGINEERING	41
Introduction	43
Retention of Tubers	43
Weather Protection	44
Insulation	44
Terms and symbols	45
Calculation of (U) values	45
Vapor barriers	46
Psychrometrics for Potato Storage	46
Psychrometric properties	47
Psychrometric charts	48
Calculation of cooling requirements	49
Calculation of ventilation requirements	50
Ventilation Systems	51
Ambient Air Ventilation	51
Natural Convective Ventilation (NCV)	51
Forced Draft Ventilation (FDV)	52
Ventilation with Artificially Cooled Air	52
Evaporative Cooling	52
Refrigeration	52
Humidification Systems	53
Air Distribution	53
Resistance to air-flow	53
Size and distribution of ducts	53
Recirculation	57
Inlet and exhaust openings	59
Fan choice	59

6 STORAGE MANAGEMENT	63
Introduction	65
Pre-storage Phase	65
Storage Phase	65
Drying	65
Curing period	65
Holding period	66
Conditioning	66
Chitting/Pre-sprouting	66
Management Practices	66
Temperature monitoring	66
Humidity monitoring	67
Temperature control	67
Humidity control	67
Post-storage Phase	67
7 ECONOMICS OF STORAGE	69
Introduction	71
Increase in returns	72
Structure costs	72
Management costs	73
Loading and unloading costs	73
Interest charges	73
8 APPENDICES	75
A1 – Conversion Factors	77
A2 – Insulation and Insulation/Condensation ..	79
A3 – Psychrometric charts	81
A4 – Refrigeration Equipment	93
A5 – Post-harvest pests, diseases and disorders ..	97
A6 – On-farm evaluation of seed stores	101

INTRODUCTION

The Storage System

INTRODUCTION

The Storage System

Storage moves potatoes through a period of time to make them readily available to consumers and to prevent wide fluctuations in supply. Consumer requirements, which control this potato movement, include potatoes for human consumption, for seed and for processing. Requirements may be for either local or export markets.

Potato storage that makes the vegetable available when needed to a certain extent replaces production on a continuous basis. Continuous production is a procedure virtually impossible in most countries. However, by increasing and prolonging production periods storage requirements are reduced.

Storage facilities add to the cost of producing potatoes -- potatoes from storage always cost more than freshly harvested potatoes.

Think of storage as analogous to the reservoir used to control stream flow and prevent flood damage or drought on a river system. The river reservoir is designed to accumulate excess flood waters during the rainy season for release gradually during the dry season when downstream needs for water are greatest. By knowing when and how much water must be released from the reservoir, it is possible to regulate the flow through the river channel to prevent floods and droughts. At least a minimal flow of water is usually maintained at all times.

The storage reservoir absorbs the surplus flow of potatoes during the new harvest for consumer use later. Potatoes are released to meet demand, perhaps during the planting or growing season. The analogy continues when storage is so planned and controlled that at least a minimal supply of

potatoes is available at all times. Care should be taken, however, to only place the quantity of tubers required to satisfy future consumer demands in the storage reservoir. Over-use of the reservoir will result in over-supply, low prices and thus financial loss.

When the storage reservoir functions properly it helps regulate and smooth out the supply of potatoes to the market by reducing sharp peaks of over-supply and depths of shortages. This, in turn, helps to stabilize and reduce excessive price fluctuations. Commonly, a stable supply and price results in increased consumption.

Information on influence of over-supply or under-supply on prices and demand is of utmost importance to best regulate flow of newly harvested potatoes into the storage reservoir and the outflow of stored potatoes from there to the market. Detailed information on production patterns, marketing systems, and total and varying consumer demands is necessary to determine overall storage patterns and for meeting either national or regional requirements.

Storage of potatoes, for either direct consumer use or for seed, must be an integrated part of the potato production process. The triad of production-storage-demand is a multiple approach based on the consideration that potato production should be in terms of quantities of tubers made available to consumers. Many pre-harvest factors affect tubers after harvest. In the case of seed tubers, post-harvest and storage factors can severely influence field production.

The interaction of many factors determine the success or failure of a storage activity. These factors and their importance are discussed in detail in this publication.

STORAGE NEEDS

STORAGE NEEDS

Potato storage must form part of and be acceptable to both production and demand patterns. Where continuous production and harvesting are impossible, storage is a needed function to move potatoes in a controlled fashion through time. Thus, particular storage needs are to a large extent determined by total and specific consumer requirements and the magnitude, duration and frequency of harvests. These factors together with variable storage costs and social conditions make storage needs very location specific. There is no such thing as the best storage system. Different systems will be more or less appropriate under different technical, economic and social conditions.

Some examples of ways in which production, demand and marketing patterns influence storage needs are given below.

Consumer requirements, both total and specific, may or may not be stable throughout the year or from one year to the next. Information on the magnitude and stability of these variations and demand trends is required to determine storage needs.

If, for simplicity, we consider that total demand in a given location is constant, then we can see in Figures 1 to 5 how the magnitude and frequency of harvests influence storage needs.

In Figures 1 and 2 total annual production is equal to the demand. In Figure 1 a single annual 2-month harvest requires that 16.7 percent of the total production be marketed directly during those 2 months and the remaining 83.3 percent be stored and released to the market during the

One Annual Production Season
Total Production = Demand

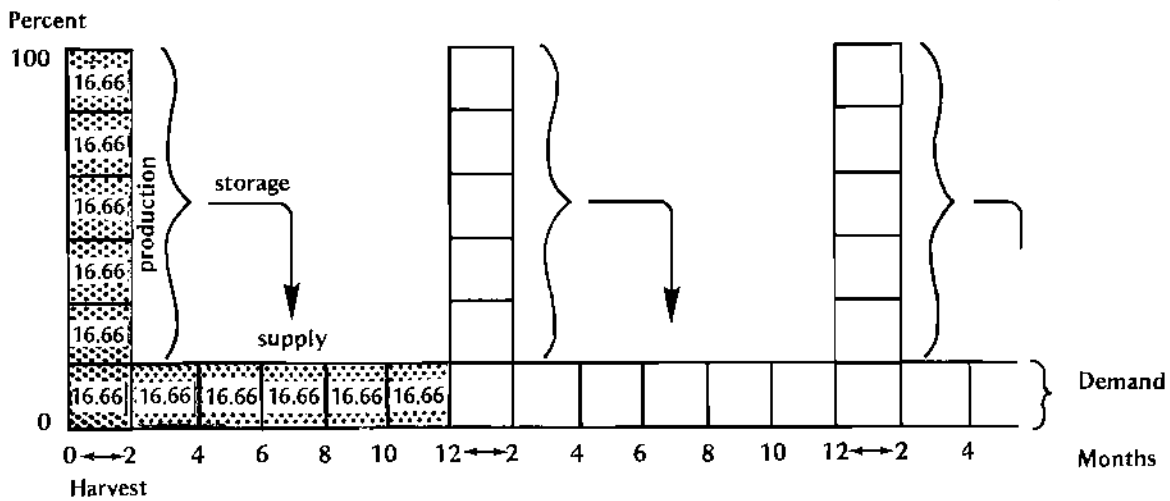
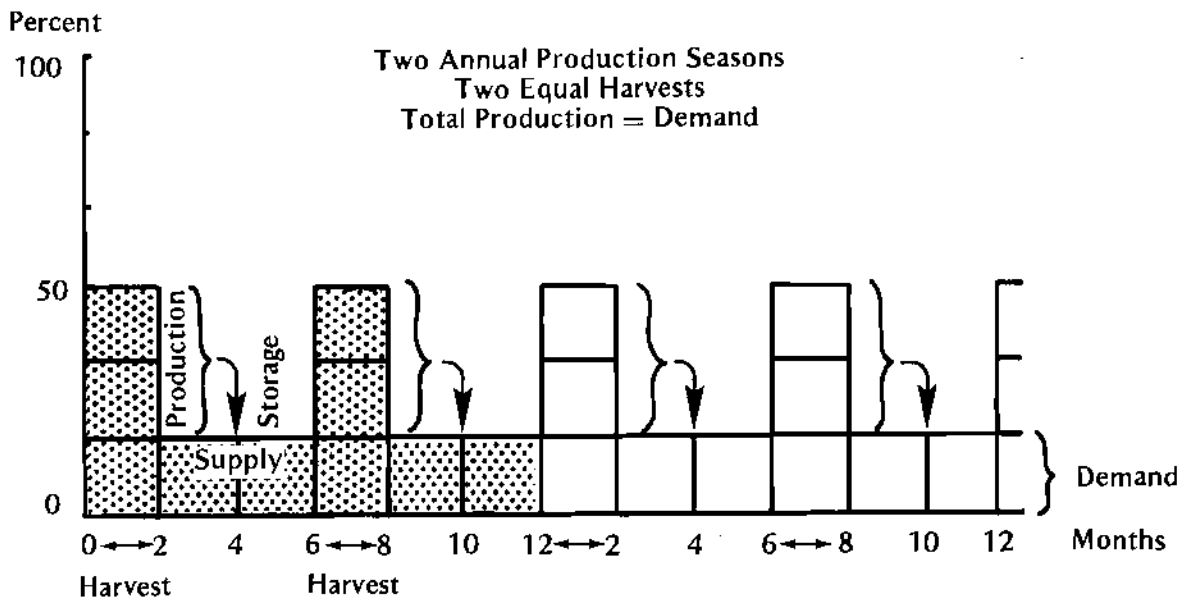

Figure 1. Influence of production pattern on storage needs (one annual production season). Total production = demand.

Figure 2. Influence of production pattern on storage needs (two annual production seasons, two equal harvests). Total production = demand.



following 10 months to provide an even supply which satisfies the demand. This situation requires large scale and long duration storage. In Figure 2, two annual 2-month harvests are equal in both magnitude and frequency within the year. Each harvest produces half the quantity of that produced in the single harvest of the Figure 1 and 33.3 percent of which is marketed directly and the remaining 66.6 percent stored and released evenly during the following 4 months. This situation requires smaller scale and shorter duration storage than in Figure 1. Additionally, the same storage facilities can be used for the two storage seasons.

Figures 3 and 4 illustrate cases of over and under production in single annual harvests and the consequent effects on storage and supply. In the case of over production only that harvest surplus which is required to satisfy future demand should be placed in the storage reservoirs. Over-storage will result in even greater financial losses through depressed prices than does over-production alone. Where there is a deficit in total production the storage policy and management will determine the distribution of this deficit.

A more complex situation is illustrated in Figure 5. Although the total production of the two annual harvests is equal to the total demand an even supply to satisfy this demand cannot be maintained because the two harvests are unequal in magnitude. Thus, as illustrated in Figure 5, the production surplus of the first harvest should not normally be stored, while the second smaller harvest results in a deficit. Because in most situations stored tubers compete poorly on the market with fresh tubers but cost more to cover the additional costs of storage, the theoretical and technical possibility of storing the surplus from the first larger production season over into the deficit period following the second smaller production season will rarely be feasible in practice. Of particular importance in managing such a situation is a knowledge of to what extent over-supply or under-supply influences prices and demand.

Demand and marketing and distribution patterns similarly influence storage needs. As an example we can examine alternative patterns of distribution of seed tubers from seed producers to seed users in a given location and see the influences which these have on storage needs.

We can identify three major patterns by which

Figure 3. Influence of production pattern on storage needs (one annual production season). Total production greater than demand. ▶

Figure 4. Influence of production pattern on storage needs (one annual production season). Total production less than demand. ▶

Figure 5. Influence of production pattern on storage needs (two unequal production seasons). Total production = demand, unequal production results in uneven supply with waste and deficit. ▶

One Annual Production Season
Total Production Greater than Demand

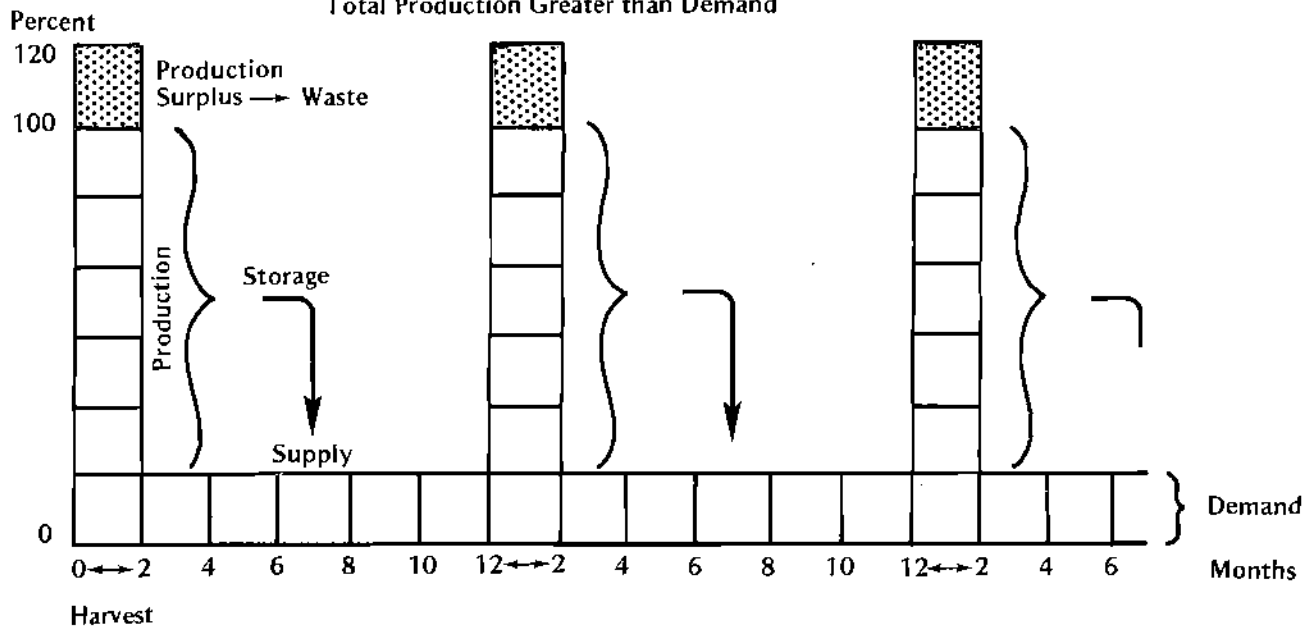

One Annual Production Season
Total Production Less Than Demand

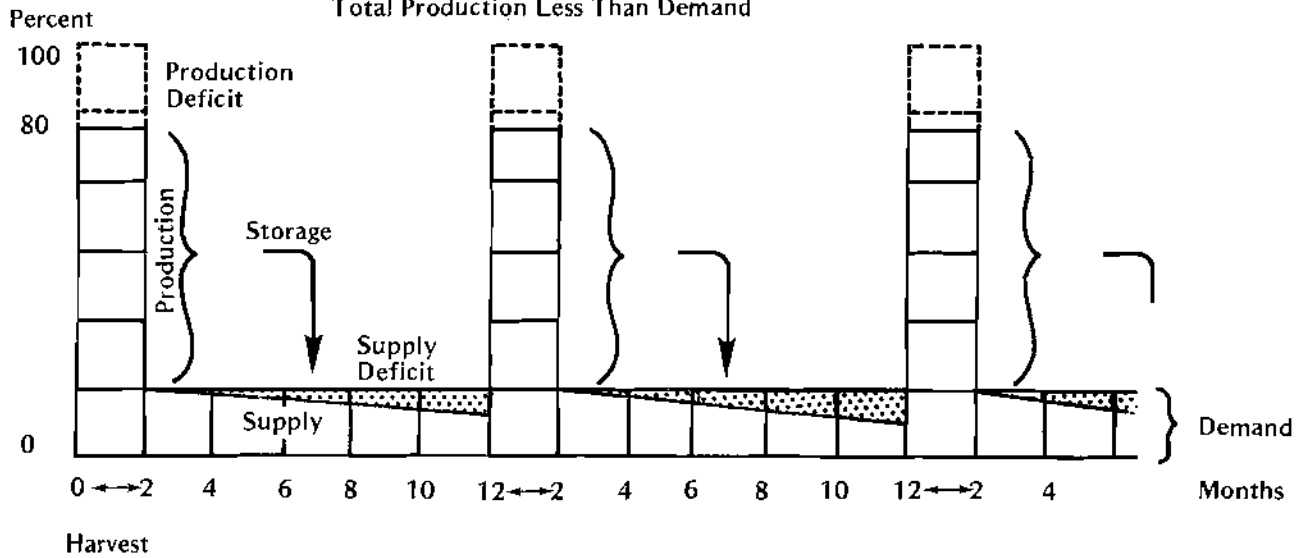

Two Unequal Annual Production Seasons
Total Production = Demand
Unequal Production = Uneven Supply (Waste and Deficit)

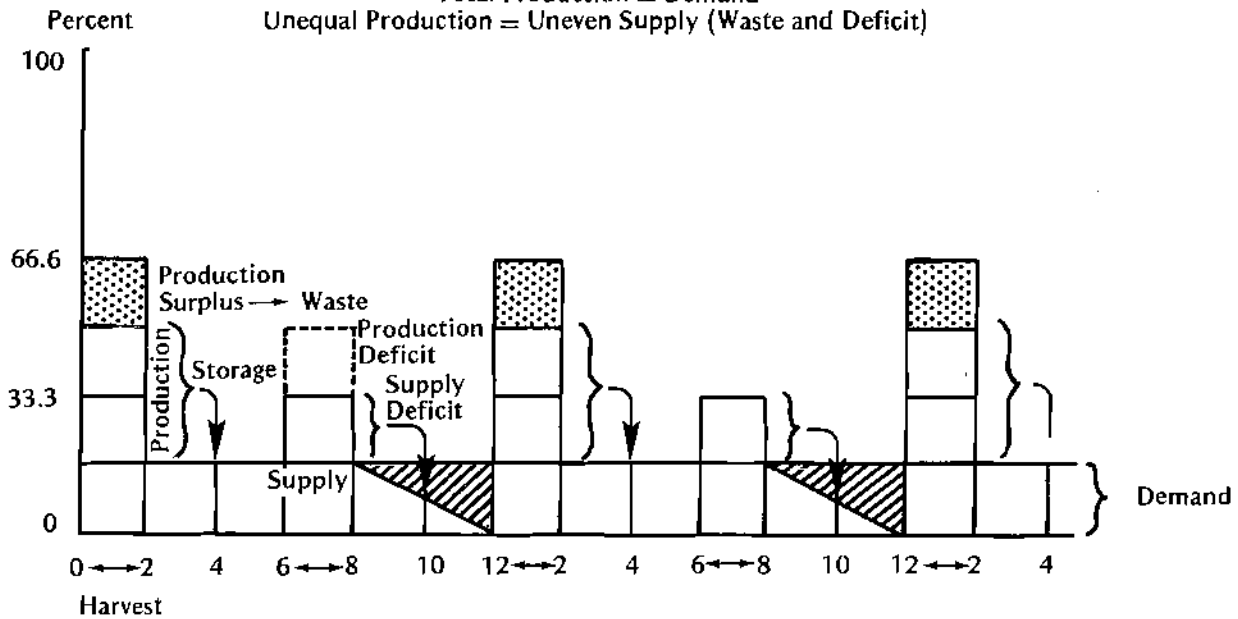

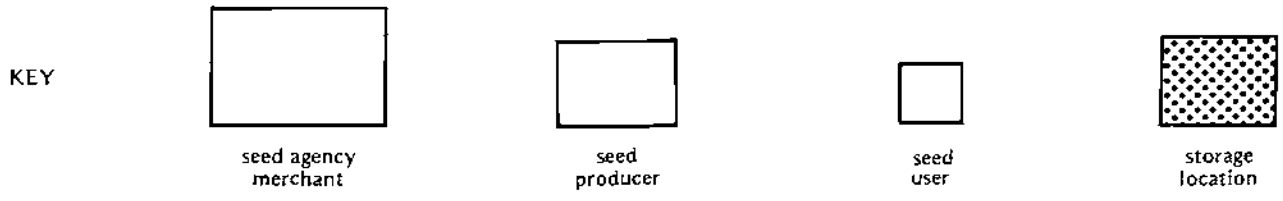

Alternative 1 – Distribution through agencies/merchants. Large-scale storage by agencies/merchants.

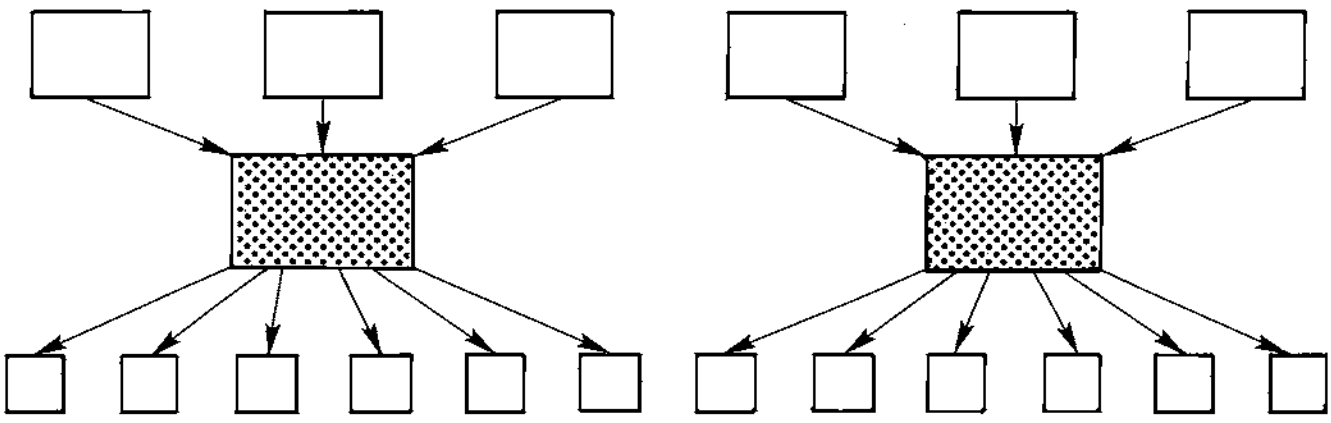

Alternative 2 – Distribution at planting time. Medium-scale storage by seed producers.

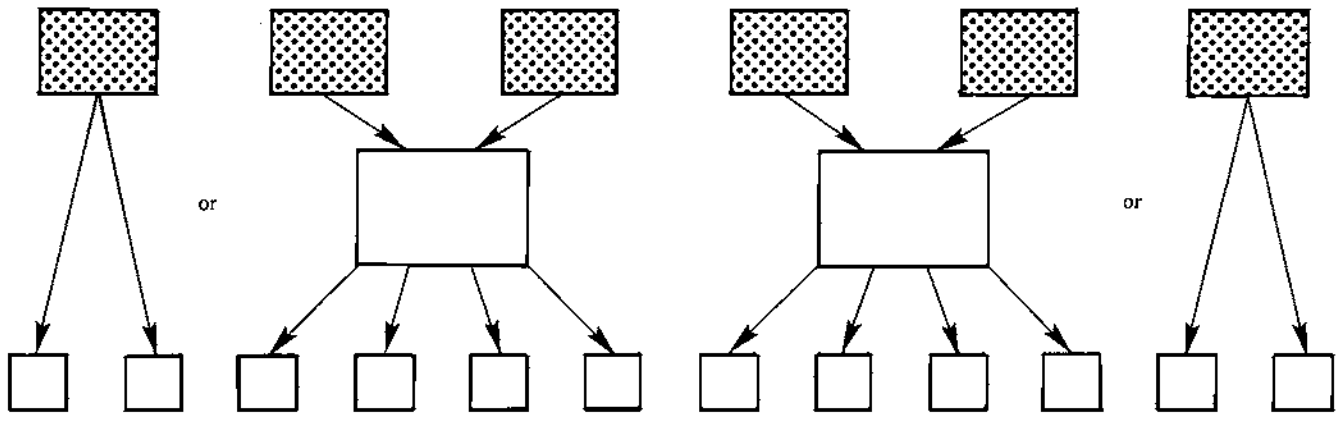

Alternative 3 – Distribution at harvest. Small scale storage by users.

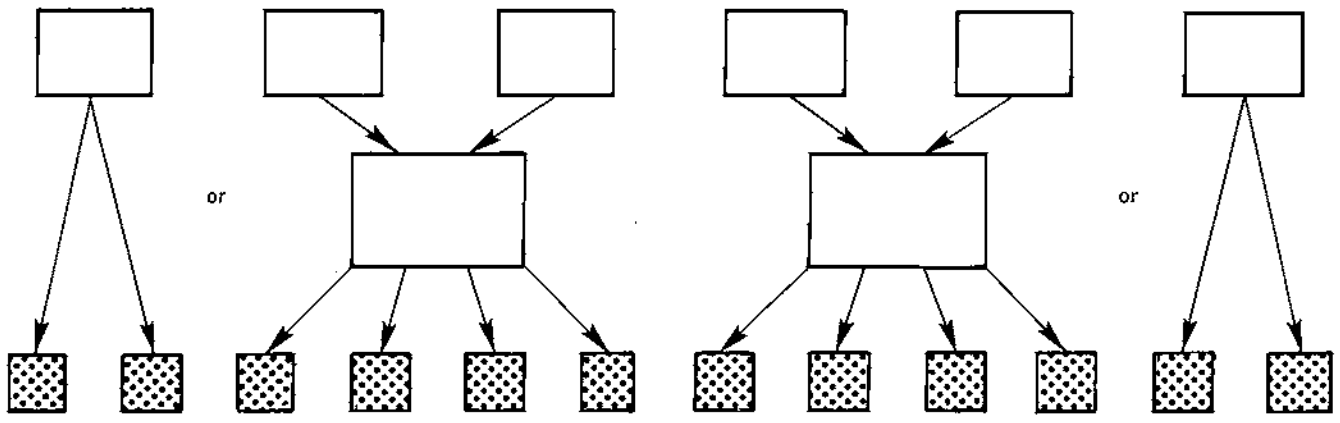

Figure 6. Three alternate seed distribution patterns with differing storage needs.

seed tubers are distributed and which have different storage needs (Figure 6). First, the seed at harvest time may be collected and stored by one or more centralized seed agencies or merchants and then sold and distributed to users at planting time. This system demands few large scale stores. Second, the seed may be stored by the seed producers themselves and sold and distributed to seed users at planting time, either directly or through seed agencies or merchants. This system requires a larger number of medium scale stores. Third, seed tubers may be sold and distributed, again either directly or through seed agencies or merchants, to the users at harvest time and then stored by the individual farmers until planting time. This system requires a still larger number of smaller scale farm stores. Additionally, both seed producers and users may store seed tubers for their own future planting. These alternatives

are not exclusive and in any one location one or more of them can operate side by side provided that adequate flexibility exists in the pricing system. A rigid pricing system based on a single marketing and distribution pattern will automatically exclude alternative distribution and storage systems.

These examples illustrate that detailed information on production patterns, marketing and distribution systems, and total and different consumer demands are required before overall storage patterns and needs can be established either on a national, regional or individual basis. Such information will influence not only the overall storage needs but will also affect detailed technical decisions because, for example, larger scale and longer duration storage facilities generally require higher levels of storage sophistication.

THE POTATO

Potato Tubers

Post-harvest Losses

Physical factors

Physiological losses

Pathogenic losses

Methods of Loss Reduction and Control

THE POTATO

Potato Tubers

A major aim of any storage system is to keep storage losses as low as possible. Potato tubers (Figure 7) are living plant organs. They consume oxygen and give off carbon dioxide and heat. The behavior of this living potato tissue in storage is influenced not only by the storage environment but also by genetic variety, agronomic practices during growth, pest and disease attacks and particularly by the physical condition of the tuber. Thorough understanding of this living tissue and the influencing factors are necessary if storage losses are to be kept to a minimum.

Post-harvest Losses

Post-harvest losses reduce either quantity or quality or both. Quantitative losses of potatoes are readily apparent. Qualitative losses, that are frequently underestimated, are important because they can considerably reduce a crop's value. Both quantitative and qualitative losses result from physical, physiological or pathological causes or combinations of all these. Normal acceptable storage life of the potato is terminated by rotting, wilting or sprout growth or various combinations of these, all being affected by the physical condition of the tubers.

Physical Factors

Losses due to physical factors caused by mechanical injury are frequently overlooked. The added complexity of secondary physiological and pathological losses resulting from physical injury makes them difficult to estimate. Mechanical injury occurs in many forms and arises at all stages: from pre-harvest through harvesting and handling operations such as grading, packing and transporting, to exposure in the market and finally in the home. Up to three-fourths of total tuber damage happens at harvest time although significant injuries occur each time tubers are handled. It is not uncommon for a third of the crop to be seriously damaged mechanically. Seriously damaged tubers should never be stored.

Mechanical injury may broadly be divided into two categories: *shatter*, when the outside skin is damaged; and *internal bruising* or *black spot*, when the tuber flesh becomes dark and discolored and is not necessarily associated with a break in the skin. Shatter injury may be further divided into *scuffing*, in which the skin only is damaged and *flesh injury*, which is deeper. All types of damage may be caused by the same impact. Tuber condition frequently determines which type of damage is sustained.

Factors influencing the amount of injury during harvest and handling include: soil condition, tuber condition, temperature, harvester operation, handling care and design of harvesting and handling equipment.

Obviously, soil condition at harvest will greatly influence damage levels. This in turn reflects care taken originally in site selection and preparation. Heavy clods and stones, especially angular or pointed ones, increase damage levels. In general, damage increases with both extremes of wet and dry soil conditions, with very dry soil being a particular problem.

Within a variety the degree of shatter and internal bruising is influenced by dry matter content and turgidity of the tubers. A direct correlation exists between incidence of internal bruising and content of dry matter: high dry matter leads to high bruising. Dry matter is influenced by growing conditions and by variety. Variety, soil type and temperature also influence such factors as tuber shape and skin strength which in turn greatly

Figure 7. The Tuber.

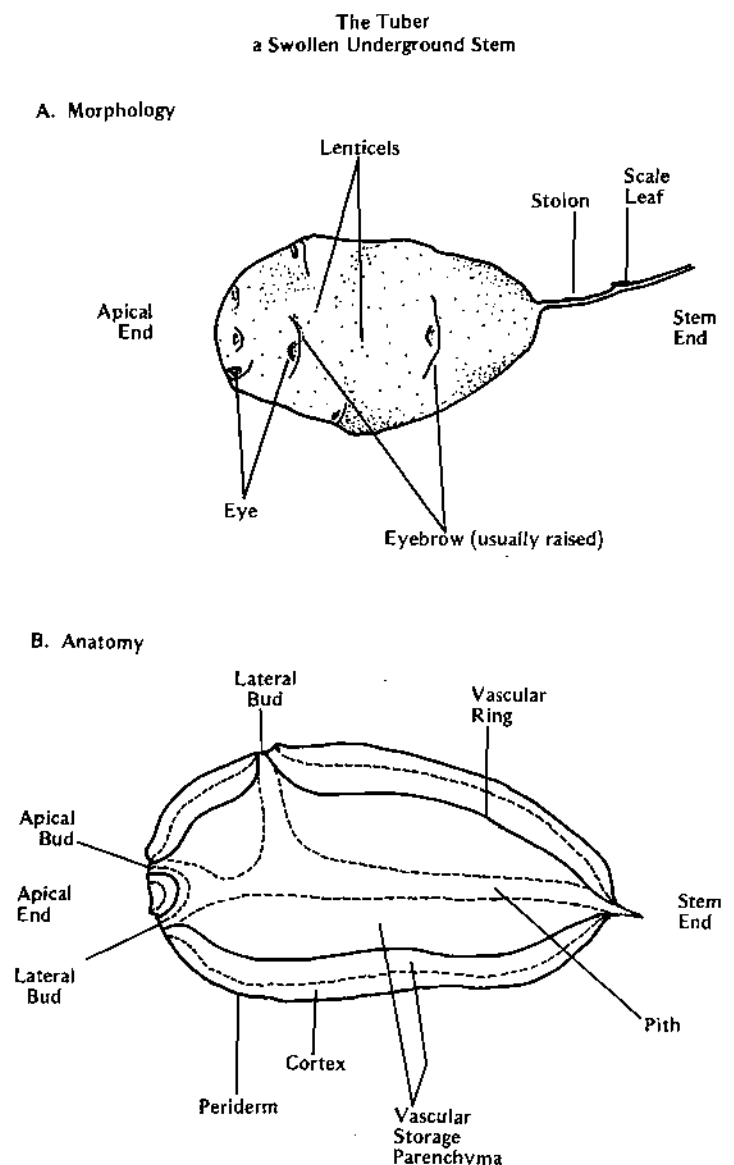

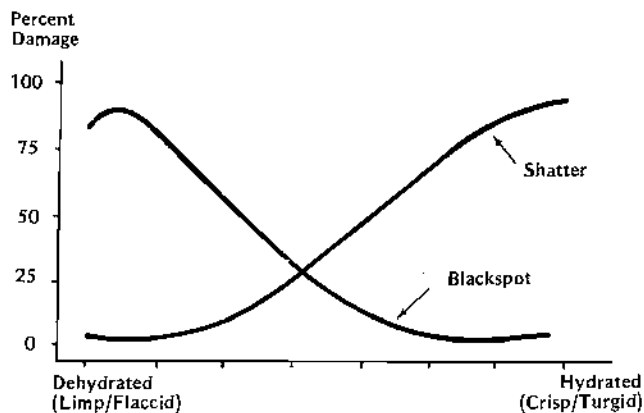

Figure 8. Tuber damage: Effect of tuber hydration on damage levels. (Adapted).

influence the incidence of shatter. Flaccid or flabby, limp tubers are more prone to bruising (Figure 8). Thus, their susceptibility to damage increases with storage time. Because wilting is aggravated by sprout growth, bruising is also more severe in sprouted than unsprouted tubers. Similarly maturity at harvest time influences the degree of scuffing. If tubers must be harvested prior to natural maturity of the crop, destroy foliage either by physical or chemical means about 15 days previously depending on local experience with given varieties and environmental conditions.

Potatoes are more susceptible to mechanical injury at low temperatures of about 5°C (Figure 9). Under certain conditions injury may be reduced by raising the temperature of susceptible tubers before handling operations such as grading. Susceptibility to bruising is reportedly associated with growth under potassium-deficient conditions. Obviously the care of undertaking either manual or mechanical harvesting and handling operations considerably influences damage levels.

In addition to gross physical losses, even minor injury will result in vastly increased physiological and pathological losses. Damaged produce always has a shorter post-harvest life than undamaged produce.

Figure 9. Tuber damage: Effect of tuber temperature on damage levels. (Adapted).

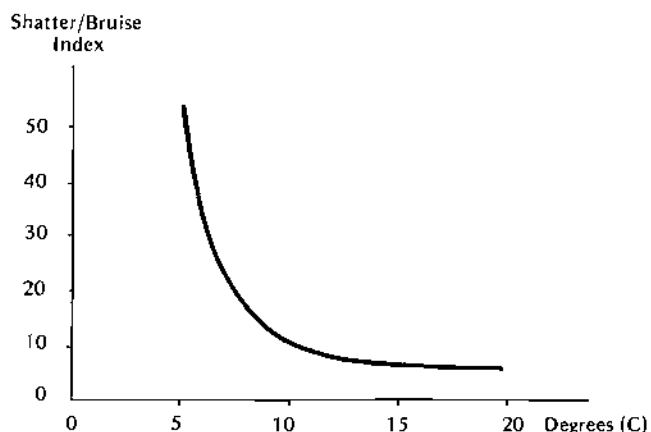

Physiological Losses

Because harvested tubers are living organs, physiological losses will occur due to exposure to extremes of temperature, through natural respiration of dry matter, and through transpiratory losses of water. The magnitude of such losses depends on storage environment but will always be greater in damaged and diseased tubers than in sound healthy tubers.

Physiological damage is possible from exposure of tubers to extremes of either high or low temperature prior to, during, or after storage. Do not leave tubers exposed to direct sunlight after harvest. Such exposure stimulates undesirable greening in consumer potatoes and overheating of tubers which in severe cases results in cell death and blackening. Black heart symptoms may develop at very high storage temperatures. This discoloration and breakdown of the inner tissues of tubers is a result of asphyxiation. Asphyxiation occurs more rapidly at high storage temperatures which cause a high respiration rate and, thus, a larger oxygen requirement.

Tubers exposed to freezing temperatures (about minus 2°C) are injured because of internal ice formation. Even slightly frozen tubers exhibit discoloration in the vascular ring. More prolonged exposure leads to a blue-black necrotic discoloration of the pith in addition to necrosis of the vascular tissue. Tubers frozen for 4 to 5 hours seldom show internal discoloration symptoms, but death of tissues is so widespread that the thawed tuber becomes wet and soft and oozes liquid. Prolonged exposure to temperatures only slightly above freezing may cause low temperature breakdown resulting in reddish brown discolored blotches or patches in the flesh and skin.

Tuber respiration during storage results in dry matter loss. At storage temperature of 10°C this loss represents approximately 1 percent to 2 percent of fresh weight during the first month and about 0.8 percent per month thereafter, but rising to about 1.5 percent per month when sprouting is well advanced.

The most important effect of tuber respiration is the production of *respiratory heat* and its subsequent influence on storage temperatures and ventilation systems. The rate of respiration is dependent upon the temperature and is minimum at about 5°C (Figure 10). If an arbitrary value of 100 is given to respiration at 5°C, that at other temperatures would have the following approximate values:

0°	—	270
5°	—	100
10°	—	120
15°	—	130
20°	—	220
25°	—	380

The production of respiratory heat is significant and is equivalent to approximately 2.5 Kcal/g CO₂ produced in respiration and can be gauged

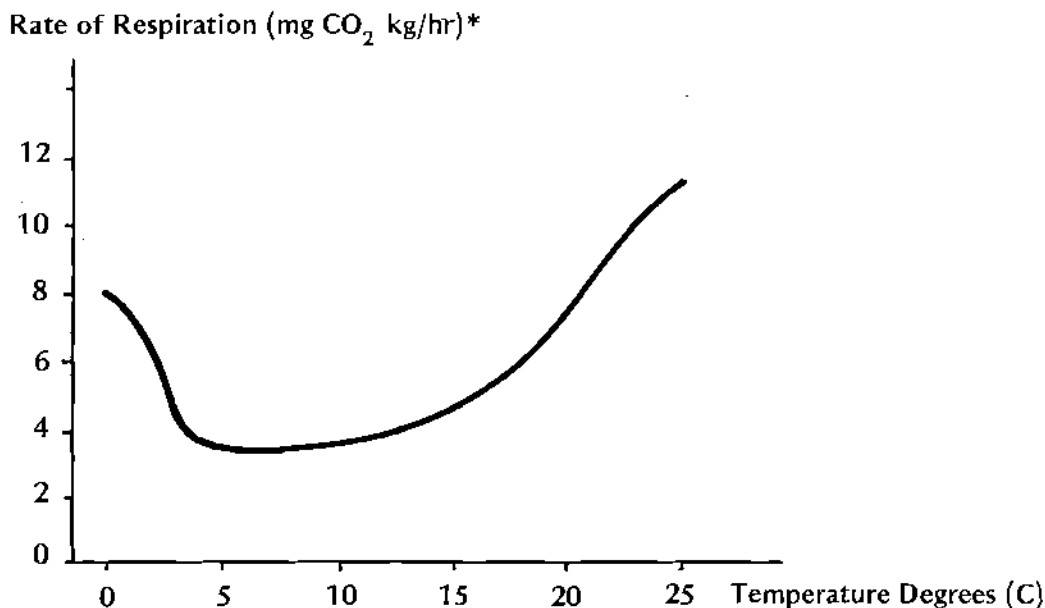

* For every g of CO₂ produced in respiration, 2.5 kcal of energy are released. Therefore in range of 5 to 15°C approximately 8 to 12 kilocalories of heat per TM/hr are produced.

Storage temperature (°C)	0	5	10	15	20	25
g CO ₂ /TM/24 hrs	192	80	100	113	192	264
kcal/TM/24 hrs	480	200	250	282	480	660

Figure 10. Tuber respiration. (From *The Potato*, by W. G. Burton).

from the table below. If this heat were not removed then the temperature of the potatoes would rise, theoretically, by at least 0.25°C per 24 hours.

Approximate Heat Output of Potatoes During Storage

	<u>kJ</u> hr/ton	<u>watts/ton</u>
Immature potatoes at store loading. . . .	259	72
Potatoes stored at 10°C	65	18
Potatoes stored at 5°C	29-50	8-14
Well sprouted potatoes	104	29
Senescent sweetening	208	58

If tubers are kept in an oxygen-deficient environment, several types of damage occur, including fermentation, off-flavor, tissue collapse and death.

All water lost before tubers are sold means a loss of sales income because potatoes are sold by weight. Water loss in excess of 10 percent may af-

fect tuber marketability because of their poor unattractive, shriveled appearance. Water is lost from tubers by evaporation.

The rate of loss from any particular sample of potatoes is proportional to the water vapor pressure deficit (VPD) or drying power of the surrounding air. The rate of loss under any given VPD is restricted by the periderm or outer skin layer of mature potatoes. Removal or damage to the periderm increases evaporation rate. Freshly harvested immature tubers lose water more rapidly than mature tubers because immature skin is more permeable to water vapor. Also, because the surface of sprouts is more permeable to water vapor than is the periderm of the tuber, water loss increases when sprout growth commences. Average water loss from mature undamaged tubers is approximately 0.14 to 0.17 percent tuber weight/week/mbar VPD. This can rise to 0.5 to 0.8 percent/week in damaged tubers. Similarly, each 1 percent by weight of sprouts increases evaporative loss by 0.07 to 0.1 percent/week/mbar VPD. Typical

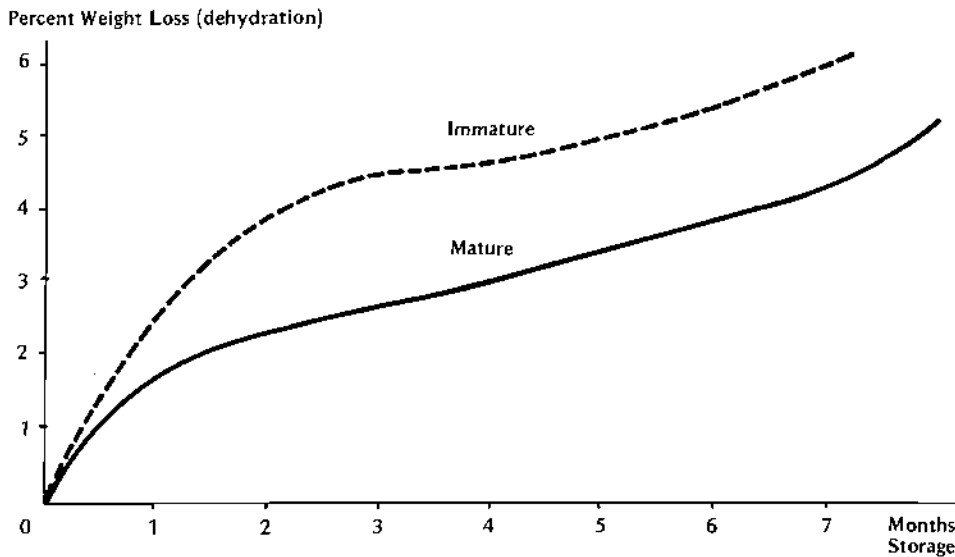

Figure 11. Water loss. Average weight loss in well-stored mature and immature tubers at 4°C to 10°C. (Adapted).

weight loss/dehydration curves are shown in Figures 11 and 12.

The drying power or VPD of the air surrounding tubers is low as long as the air remains still. Ventilation involving more than the necessary minimum of air exchange, inevitably increases water loss. The VPD of the air surrounding the tubers is influenced by its relative humidity and temperature: at any given relative humidity the VPD increases with increase in temperature, and conversely at any given temperature the VPD decreases with an increase in relative humidity.

A further physiological cause of storage loss is

sprouting. Sprouting reduces marketability as well as resulting in increased water and respiratory losses. Damaged and diseased tubers sprout sooner than sound healthy tubers. Normally, at harvest tubers are dormant. The buds will not grow even under favorable environmental conditions. In considering factors that influence length of dormant period, remember that growth is a complex process with the two most important factors being variety of potato and the temperature of storage. However, other factors that normally are of minor importance sometimes may have an overriding effect.

Figure 12. Water loss. Influence of damage and curing on water loss. (Adapted).

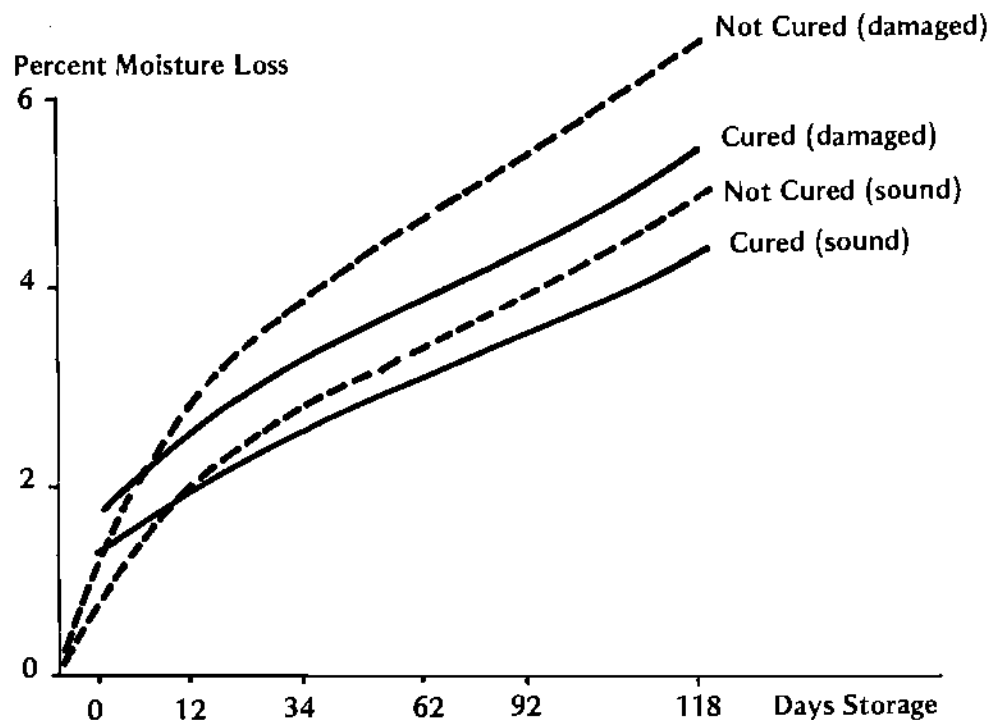

The exact effect of temperature during storage depends on its influence upon which of many reactions may be limiting growth at any particular time. Ordinarily the higher the storage temperature over a range of about 4°C to 21°C, the shorter is the residual dormant period. The most critical temperatures are between 4°C and 10°C. It is possible, however, that tubers stored first at low temperature followed by storage at 10°C could have a shorter dormant period than following continuous storage at 10°C. Varieties react differently to fluctuating temperatures.

Growth of sprouts follows dormancy break, although there is no apparent connection between length of the dormant period and the subsequent rate of sprout growth. The main factors influencing rate and form of sprout growth are variety of potato, previous storage history, temperature, humidity, composition of the atmosphere, and degree of exposure to light. Sprout growth is slow at temperatures of 5°C and below. Above 5°C an increase in temperature causes an increase in sprout growth up to an optimum temperature of about 20°C above which the growth rate decreases. Humidity of storage may affect rate of sprout growth particularly when this is well advanced. The form of the sprouts may also be affected, for example, the degree of branching is greater under dry conditions and the production of adventitious roots is greater under humid conditions. Sprout growth is also stimulated by an increase in CO₂. Potato sprouts grown in light develop chlorophyll and are shorter and sturdier than those grown in the dark. Often after storage of seed tubers for 7.5 weeks at 17°C in continuous light the average length of the longest sprouts on the illuminated tubers were less than 3 percent of those on control tubers in the dark. Additionally, more root initials develop on sprouts stored in the light.

Further storage and market losses may result from various physiological disorders, frequently resulting from abnormal pre-harvest growing conditions, but which affect tuber shape and physiological state (Appendix A5).

Finally, changes in the sugar levels considerably influence culinary and processing quality of tubers.

Figure 13. Sugar changes during storage. General changes during prolonged storage. A -- Low temperature sweetening. B -- Senescent sweetening. (From *The Potato*, W. G. Burton).

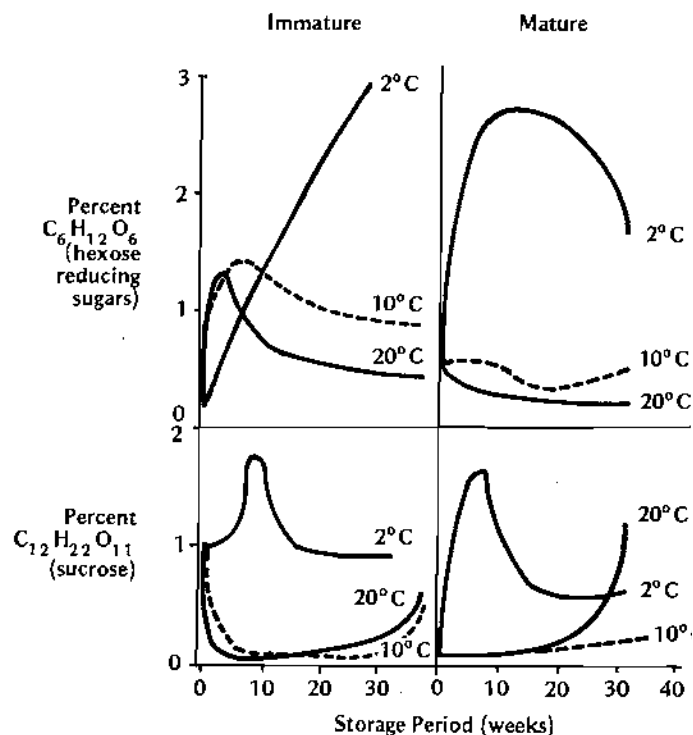
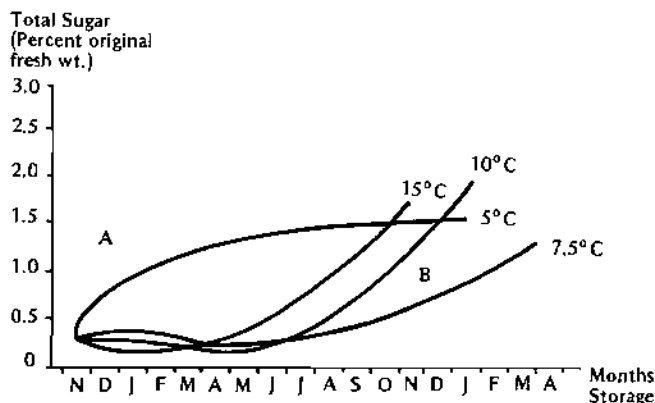

Figure 14. Sugar changes during storage. Changes in sugar content in mature and immature tubers stored at different temperatures. (From *The Potato*, W. G. Burton).

In addition to an initial adjustment in sugar content immediately following harvest, storage temperature influences sugar content later. A decrease in temperature, particularly below 6°C causes an increase in sugar content. Both sucrose and reducing sugars accumulate, but not necessarily in the same proportions at different temperatures (Figures 13 and 14). Tubers affected with low temperature sweetening may be de-sweetened by storage for about 2 weeks at a higher temperature of 15°C to 20°C. In addition to the increase in sugar content resulting from exposure to low temperatures, the concentration of sugar exhibits an upward trend after prolonged storage at higher temperatures, an occurrence known as senescent (aged) sweetening. Sugar content of tubers influences their culinary acceptability and it greatly influences the color of fried products. The color of fried products is mainly the result of reactions which occur between amino acids and reducing sugars. At normal frying temperatures the final color is closely correlated with the content of reducing sugars, of these the content of glucose is most closely correlated with browning. Product color may also be influenced by modifying frying temperature and time.

Pathogenic Losses

Attack by *microorganisms* probably cause the most serious gross post-harvest losses in potatoes. However, both physical and physiological damage usually predispose tubers to pathogenic attack. Such losses may cause quantitative losses of sound tissue as well as those which reduce the quality only. Quantitative pathogenic losses result from

the frequently rapid and extensive breakdown of host tissues as in the case of blight, pink rot, dry rot and bacterial soft rots. The pattern of attack is often an initial infection by a specific pathogen followed by a massive invasion by a broad spectrum of secondary organisms, commonly including soft rotting bacteria, which are only weakly pathogenic or saprophytic on the dead tissues remaining from the primary infection. These secondary invaders may be aggressive and can have an important role in post-harvest pathology, frequently serving to multiply and exaggerate the initial damage by primary pathogens. Qualitative pathogenic losses are typically the result of blemish diseases such as common scab, powdery scab, black scurf and silver scurf or deforming diseases such as wart. These diseases, although inducing little or no tuber rotting, affect the appearance of the potato and thus influence market value. Another group of diseases are those such as skin spot and rhizoctonia scurf which invade and kill potato eyes. They are of great importance on seed tubers.

Post-harvest diseases may be divided further into those in which the infection becomes established in the field prior to harvesting and those where infection occurs at or following harvest. Where infection occurs prior to harvesting, rotting usually begins immediately in the field and continues during post-harvest storage as, for example, with late blight, brown rot and pink rot. Alternatively, once established, the infection may remain latent and only manifest itself later during storage as is sometimes the case with early blight and skin spot. Where infection occurs at or after harvesting it is usually at the sites of mechanical injury as in the case of dry rot, watery wound rot, and gangrene. The majority of post-harvest pathogens are wound parasites and only rarely does infection occur through sound undamaged skin. Some pathogens, especially *Erwinia* spp., are capable of infection through natural skin openings such as lenticels, particularly following storage at very high humidity with condensation of free water on tuber surfaces.

Details of the major diseases of importance in the post-harvest phase, their symptoms and means of control are given in Appendix A5. This includes diseases caused by fungi, bacteria, viruses and physiological disorders.

Additionally pathogenic losses may be caused by insect, nematode and other animal pests such as rodents and birds. Probably the most damaging post-harvest insect is the potato tuber moth also known as the tobacco leaf miner, *Phthorimaea operculella*, and associated species. In stored tubers the initial infestation is mainly by larvae infesting the tubers at harvest. Adult moths fly readily and may migrate from the field to the storage facilities. The adult potato tuber moths lay eggs on or near the potato eye buds. Emerging larvae bore into the tubers commonly through the eyes and feed while boring tunnels. The larval damage results in direct weight loss, wounds which lead to shrinkage and secondary infection by microorganisms. Secondary infection also follows damage

caused by other pests such as slugs, wireworms, and cut worms. When potato tuber moth larvae are mature they spin cocoons on the outside of the tuber and pupate there. Adults then emerge and repeat the cycle (3-4 weeks) and also migrate back to the field.

During storage of seed potatoes heavy aphid infestation of young shoots can play a role in the dissemination of certain virus diseases, especially potato leaf roll virus. Further details of these common pests and possible control methods are given in Appendix A5.

Methods of Loss Reduction and Control

When studying ways to reduce post-harvest losses, consider that storage is only part of a total potato production system. Many pre-harvest production factors considerably influence post-harvest behavior of tubers. Site selection influences the severity of many diseases. Site preparation greatly influences levels of tuber damage at harvest time. Different varieties vary considerably in several important storage characteristics such as resistance to harvesting and handling damage, resistance to pests and diseases, length of time of dormant period and sprout growth. Different cultural practices and growing conditions significantly affect the physical condition, health and physiological state of tubers at harvest.

In addition to such pre-harvest considerations, post-harvest losses may be reduced by various physical, chemical and biological means.

Careful harvesting and improved handling techniques are essential to reduce post-harvest losses. Timing of harvest is important, both in terms of crop maturity and prevailing weather and soil conditions. Mature tubers suffer less harvest damage, particularly skin scuffing, than immature tubers. If necessary tubers should be artificially matured by destroying the haulm about 15 days prior to harvesting. Soil condition influences damage levels. All handling materials should be selected to minimize damage and tubers should never be dropped from a height greater than 15 cm to an uncushioned surface.

Potatoes put into store must be sound, dry and free of soil. Always protect tubers from rain and direct exposure to sun or wind. Tubers that have been rained on should not be stored as they are liable to rapid rotting. If immediate disposal of wet tubers is not possible, wet loads should be stored temporarily in as shallow a heap as possible, to encourage rapid drying. Do not walk or stand on unprotected potatoes. Careful attention must be paid to general sanitation and cleanliness of implements, handling machinery, containers and stores so as to reduce sources of inoculum of potential pathogens. A list of disinfectants and their uses is given in Appendix A5. Dispose of old tubers by burning or burying. Potatoes left lying in the field or store are a potential source, host or reservoir for diseases and pests.

A simple and effective way to reduce both disease and moisture losses during storage is through

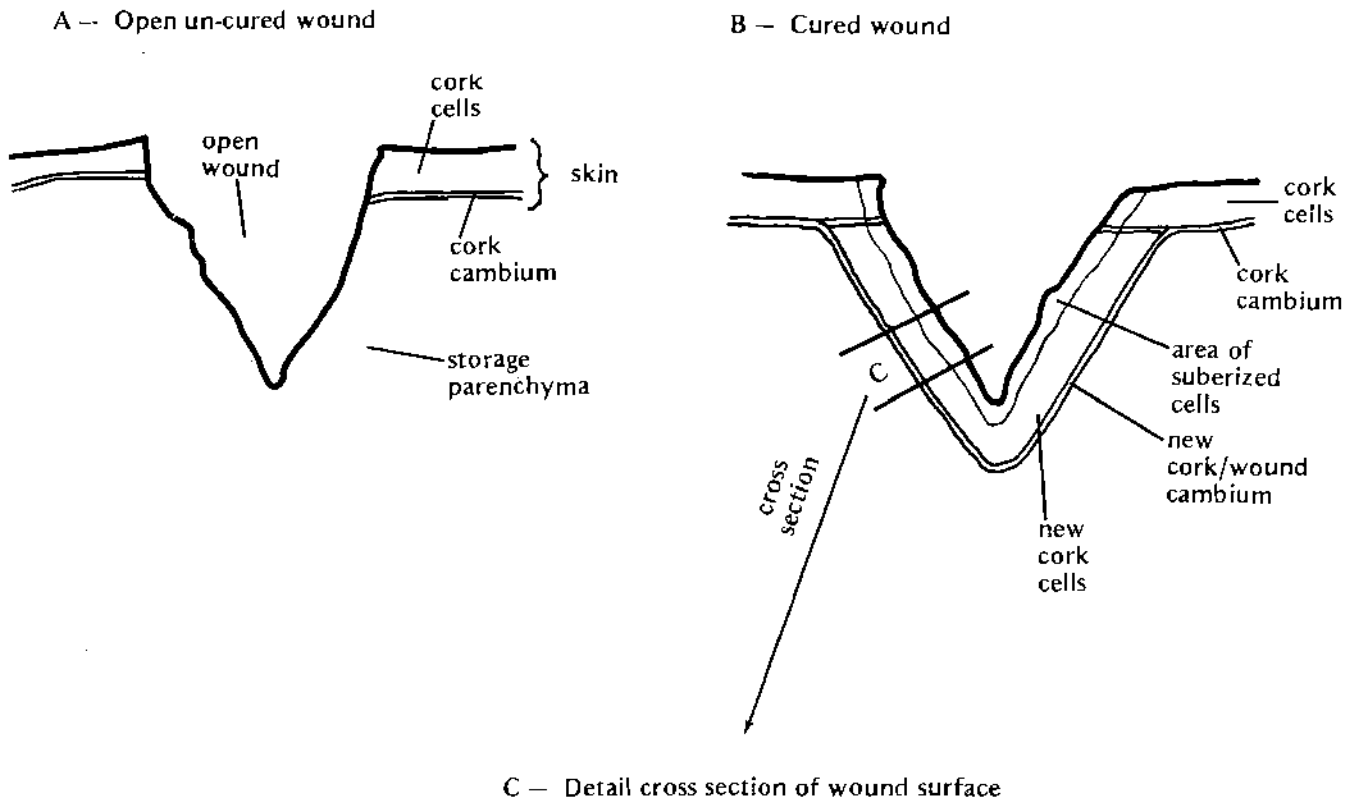

Figure 15. Curing.

adequate and timely curing. Curing is a wound-healing process during which general skin strengthening also occurs (Figure 15). It first involves suberization of cells adjacent to wounds followed by the formation of a wound periderm or cork layer that effectively retards water loss and becomes a barrier against infection. This process occurs at temperatures of 12°C to 18°C and above when

relative humidity is 85 percent or above in the presence of oxygen. At low relative humidities the reaction does not occur regardless of temperature. With a rise in temperature to a maximum of about 20°C to 25°C the reaction occurs more rapidly. Optimum conditions are considered to be a period of 7 to 15 days at 15°C and 85 percent to 90 percent humidity. In most situations curing condi-

tions may be obtained simply by slightly restricting natural ventilation of the recently harvested crop. This permits a build up of respiratory heat and moisture is evaporated from wounds and adhering soil. Curing is such an easily induced natural protective process, it is recommended as a routine procedure immediately after harvest except where risk of bacterial soft rot is known to be high.

Curing is of little value unless accomplished immediately after harvesting and handling operations. Otherwise pathogens will become established in the wound tissues before the protective periderm is formed. Once tubers are cured, they should be handled as little as possible to avoid new damage. Ideal curing takes place immediately after the crop is in the store and the potatoes should not be further disturbed until final removal from storage.

Reduced- or low-temperature storage is the universally adopted method of minimizing losses of perishable agricultural and horticultural products. However, unless properly managed and preceded by adequate curing, cold storage of potatoes may be disappointing. Low temperature storage effectiveness results from a slow-down of metabolic processes through temperature decline that reduces losses caused by respiration and sprouting. Pathogen metabolism is also slowed at reduced temperatures, so rotting is frequently arrested. Some pathogens, however, are capable of causing extensive damage even at low storage temperatures. Selected optimum storage temperatures are a compromise between several loss factors discussed above (Figure 16). Virtually no sprouting occurs in potatoes held at 5°C or below, but because of problems of low temperature sweetening, ideal storage temperatures of consumer potatoes vary from 5°C to 10°C depending on length of storage period and ultimate use of the tubers. Seed potatoes can be held for prolonged storage at low temperatures of 2°C to 4°C because low temperature sweetening is of little importance.

Refrigeration, commonly needed to maintain suitable temperatures, requires skilled management and carefully designed ventilation systems (see below). Under some situations refrigeration is not feasible. Tubers may be stored for considerable periods at temperatures in excess of those discussed earlier. Many structural and management techniques are available to reduce storage temperatures, such as making use of cooler night air.

To minimize loss of moisture by evaporation, the VPD of storage air must be kept as low as possible. This is done by maintaining relative humidity at a high level of about 90 percent. In certain circumstances this will require artificial humidification of the cool ventilating air. Avoid condensation of free water on the tubers because, as in the case of rain water, this induces rapid bacterial rotting.

In addition to reducing post-harvest pest and disease losses through good phytosanitary practices such as elimination of infested or infected tubers and plant debris, such losses in certain cases may

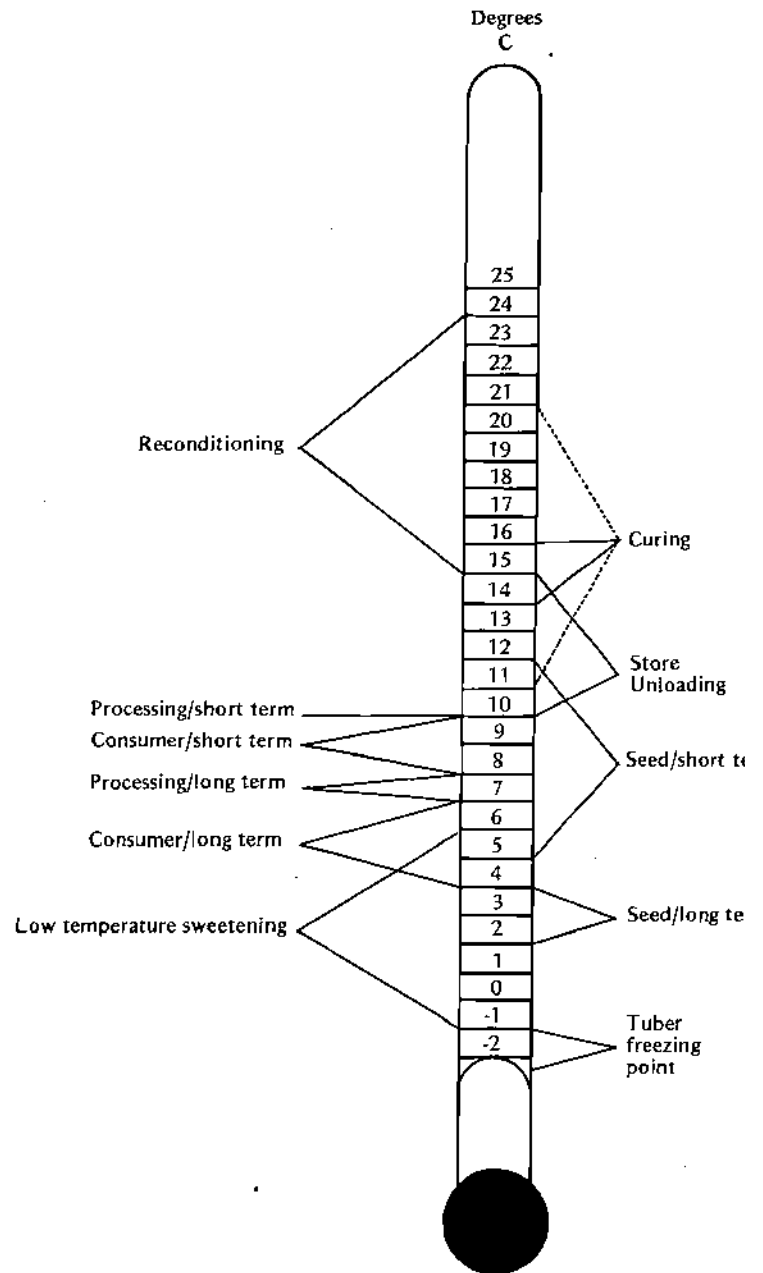

Figure 16. Storage environment temperatures.

be reduced by use of chemical pesticides. However, before successful chemical use, a thorough knowledge of the biology of the disease or pest involved is required. For pests and diseases where infection occurs primarily in the field prior to harvest, chemical and other measures are best directed at field control. While possible to control certain pests and true post-harvest diseases by direct application of pesticides to the tubers, this is not widely practiced with consumer potatoes because of problems and dangers of pesticide residues. Prior to application to food products, chemicals should be rigorously screened and then used only in strict accordance with the manufacturers recommendations and food additive regulations of the country concerned. Similar precautions apply to use of rodent poisons and chemical sprout suppressants. Such precautions are not necessary for treatment

of seed potatoes. Care should always be taken in handling and use of all agricultural chemicals.

Chemicals used on a commercial scale to control sprouting during prolonged storage at temperatures above 5°C include: MENA (naphthaleneacetic acid), tecnazene/fusarex/TCNB (tetrachloronitrobenzene), propham/IPPC (isopropylphenyl carbamate), chlorpropham/CIPC (isopropylchlorophenyl carbamate), nonanol (trimethylhexanol) and MH (maleic hydrazide). With the exception of Maleic hydrazide, which is a pre-harvest foliar spray, all the chemicals listed are used on the tubers after harvest. All these chemicals listed are active in the vapor phase, so they may be dispersed with an inert filler. They can be dusted onto the tubers as they are placed in store, or mixed with the tubers in granular formulations, or the active chemical alone may be vaporized and blown through stored tubers. The former application methods have the advantage of a continuously maintained suppressive effect through slow evaporation of the active chemical and may be applied in conjunction with simple storage methods.

The latter method of blowing the chemical through stored tubers is often simpler to apply where suitable equipment and stores are available. With solid state application the level of chemical must be sufficient to maintain an active concentration for the desired length of storage. With the fumigation method a second application is possible if required. All the above chemicals, except TCNB, inhibit the curing process and the formation of wound cork. Thus, although sprouting and the gross water loss associated with sprouting may be prevented by the application of these suppressants, weight loss may often still be disappointingly high because of the greater loss from unhealed wounds. Application delayed until after curing is complete implies the use of vaporizing chemicals which is not readily possible with simple stores. When sprout suppressants are used on consumer potatoes great care must be taken to avoid contamination of seed potatoes. TCNB is the only inhibitor which may possibly be used on seed potatoes, but this requires investigation under local prevailing conditions before the practice is recommended.

STORAGE METHODS

Introduction

Choice of Storage Methods

Alternative Storage Methods

Delayed harvest

Clamps

Multipurpose and Adapted Buildings

Purposely Constructed Potato Stores

Seed Storage Methods

Improving Storage Methods

STORAGE METHODS

Introduction

Before the selection and design of a store, some questions must be answered:

- How many potatoes will be stored and for how long?
- How many varieties and qualities will be stored?
- How many potatoes will be harvested each week?
- What are the dormant periods and other characteristics of the varieties to be stored?
- What is the climate during the storage period?

How many potatoes will be stored and for how long can be answered from an understanding of the total production demand system. Quantity of potatoes indicates size: a 100 TM store, a 500 TM store or perhaps a series of 300 TM buildings. Length of time of the storage period is important. Storage of 1 to 3 months is possible in simple Natural Convective Ventilation (NCV) or Forced Draft Ventilation (FDV) stores. Storage for more than 6 months may require the use of expensive Mechanical Refrigerated Ventilation (MRV) stores or the use of sprout inhibitors.

How many varieties and their quality is a clue to number and size of individual storage rooms, and the type of containers to be used. Each variety and each quality must be kept separate, although they can be placed in the same room. With several varieties and qualities either box storage or bags can be used. If several varieties are to be stored in bulk several small rooms will be required. Bulk storage is usually reserved for lots of 50 TM, or more, of one variety or quality.

Weekly Harvests

Potatoes must be cured for 10 to 14 days after placing in the store. Practical experience has shown that one week's harvest is conveniently cured at one time. The size of the individual rooms ideally should conform to one week's harvest.

Varietal Characteristics

If the dormant period is short, MRV stores and/or sprout inhibitors must be used if the storage period is longer than about 2 to 3 months. Varieties with a long dormant period can be held for 3 to 5 months with NCV storage or FDV storage in areas where night temperatures are below 10°C for more than 8 hours out of each 24 hours.

Climate

Knowledge of climate during the storage period is essential to specify the insulation required. It

aids in the decision on ventilation requirements of either NCV or FDV or on MRV. It must be known if humidification of the ventilation air is required.

The above information is necessary for selection and design of the required storage units.

Choice of Storage Methods

The most efficient method of storing and handling potatoes is not absolute, but is related to numerous continuously changing technical, social, economic and financial factors and conditions. Different methods may be more or less appropriate in different circumstances and even within different periods of the same storage season. Select methods in terms of acceptability to the total production-storage-demand system to yield maximum returns on the investment available and to reduce both quantitative and qualitative storage losses. Greater benefits may be obtained with several integrated storage methods and structures than with a single storage method, frequently involving large sophisticated and costly storage units.

An example of such an integrated storage system using three different storage methods is illustrated in Figure 17. In this example the tonnage (1) required during the first period (I) of the total storage season is held in simple farm stores, the tonnage (2) required in the period (II) is stored in intermediate type stores and only tonnage (3) which is required in the final (III) period is stored in sophisticated refrigerated stores.

Before integrated systems can be effectively used, information is required on how long potatoes can be economically stored using different methods under prevailing environmental conditions. Information on storage losses is used with appropriate economic and marketing data to derive an integrated system, (Figure 17).

In general, simple stores are cheaper and in most situations a higher loss level can be tolerated than for expensive storage systems.

In selecting a specific storage system the total market value of the annual crop to be stored must be considered. The reason is that one must know how much to invest in a storage system to protect the sum representing the value of the crop. Frequently the efforts and expense of producing a crop stored under inadequate conditions results in substantial losses. Often these losses could be reduced by a relatively small additional investment. However, the cost of reducing storage losses must always be evaluated against the financial and social value of that loss. For example, it may be technically possible to reduce total storage losses in a given forced draft store from 15 percent to 8 percent by installing a refrigeration unit. But if the annual cost of installing and running the refrigeration unit is greater than the value of 7 percent of the stored crop, this technical improvement could not be justified on purely financial grounds.

Finally, in selecting any storage system the importance of its technical and economic performance must continually be measured in view of its

acceptability to both the production and demand parts of the total system. If the storage is not accepted by both, it will not be used. A technically sound but inappropriate-to-the-total-system store

often remains idle. Such examples may result from storage technology transferred directly from other regions of similar climate without efforts to adapt the technology to the local production, demand and social systems. In short, storage systems must

Figure 17. Development of integrated storage systems.

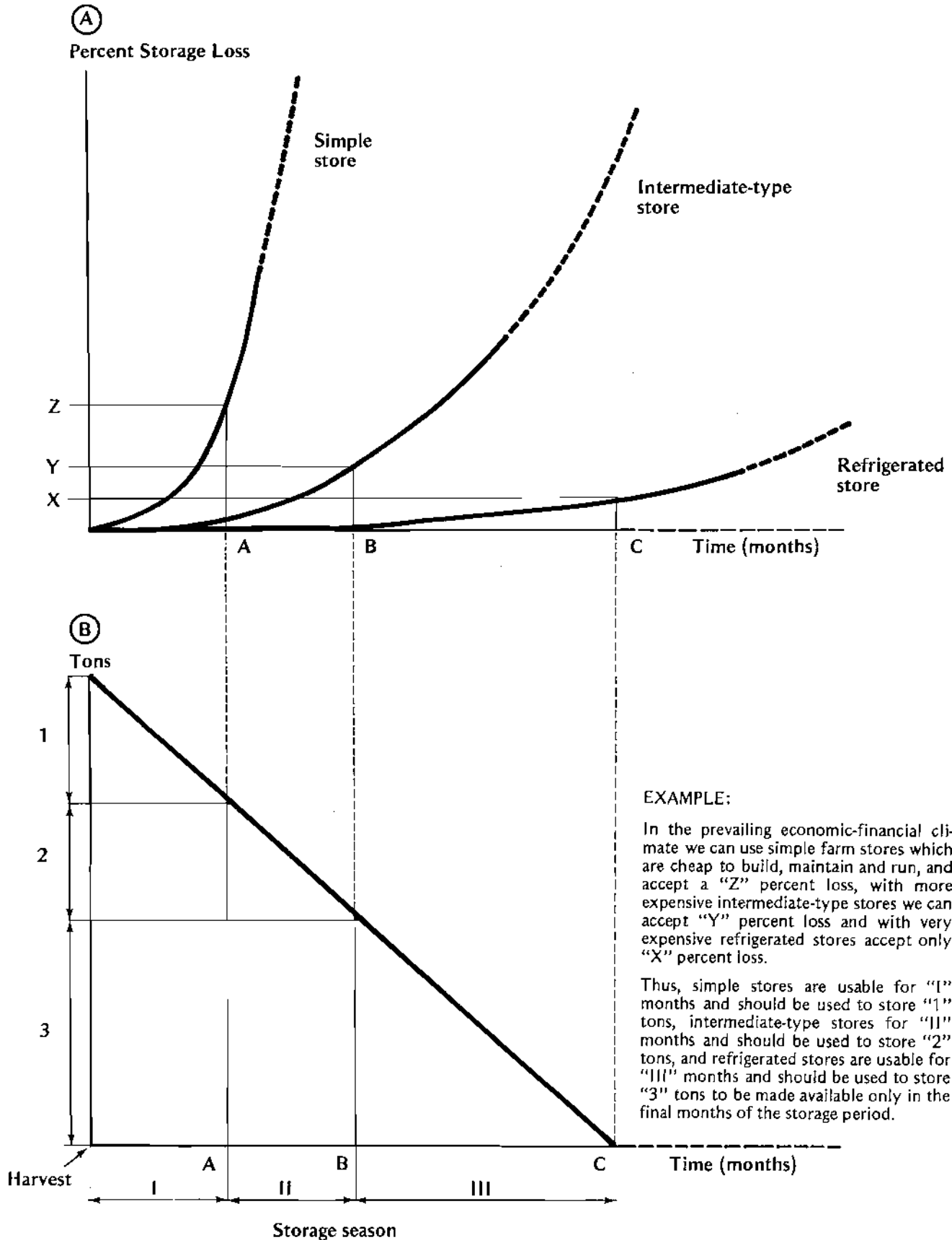

be selected and developed within the total local system requirements and not "imported" or transferred as a copy of another system.

Alternative Storage Methods

In selecting a method of storage and to design, build and manage it, consideration must be given to the location:

- in the field by using delayed harvest, or,
- in simple piles or clamps covered with straw and sometimes soil, or,
- in buildings specifically constructed for potato storage or in a suitable modified existing building.

Delayed Harvest

Delayed harvest, or in-ground storage, is the simplest method and may be successfully used for up to 3 months, depending on variety, climate, soil conditions, diseases and insects.

Delayed harvest is leaving the potatoes in the ground after the vines have matured and died. Where late season infestation of insects or disease may damage the potatoes, the vines can be killed by chemical or mechanical means.

Advantages of delayed harvest are the low cost of storage and the opportunity of harvesting carefully and doing a good job of selection with fewer workers.

Only varieties that have at least a 3-month dormant period should be considered for storage in the ground. Sprout initiation can be a problem with short dormancy varieties.

The climate should be cool with a temperature range of 0°C to 15°C. If temperatures go below 0°C, freezing damage is a possibility. If temperatures go above 15°C, perhaps to 20°C or 25°C, the soil will become too warm, causing a breakdown of the tubers. In areas of strong direct sunlight, soil temperature must be checked.

An occasional rain of about 1 cm is acceptable. But rain that leaves the soil moist for more than a few hours will result in increased tuber rotting. Increased pest damage may also result from delayed harvest. And, if tubers are not well covered, losses through greening will also occur.

The soil should be light, or sandy. Heavy soil will cake and can cause bruised and damaged potatoes. Caked soil makes harvesting more difficult.

The principal advantages of in-ground storage are:

- low cost,
- harvest can take place when potatoes are needed for the market,
- potatoes have a fresher appearance than those from other types of stores.

Clamps

Potato clamps (Figure 18) and their numerous modifications are simple structures that can be used to store potatoes in the field or near the house if security reasons require. Clamp type storage is particularly useful where capital expen-

Figure 18. Field storage clamps.

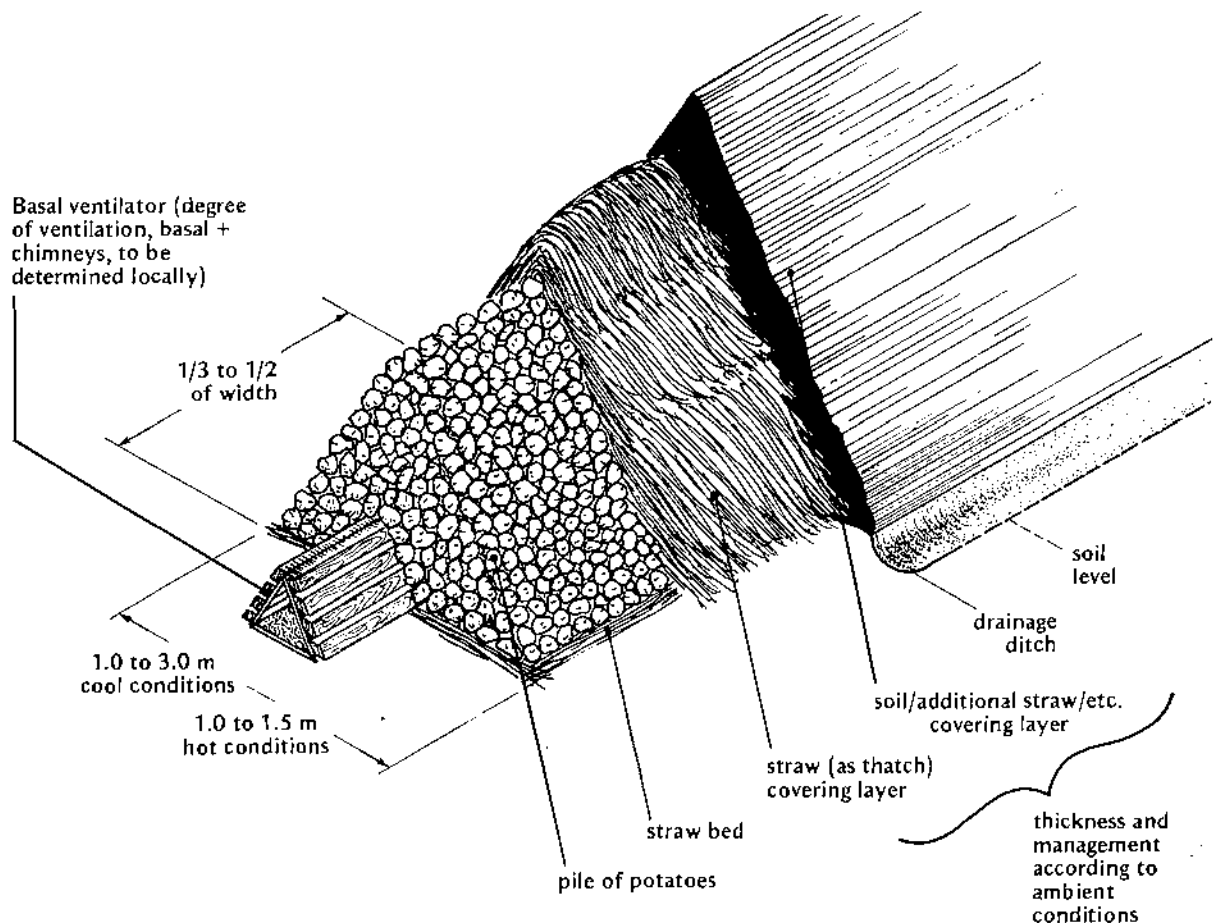

diture is not desired or where the amount of labor involved is of secondary importance. Essentially, the system involves piling the harvested tubers in heaps and covering them with alternating layers of straw and soil. Dimensions and details of the construction of the heaps varies and the system and design best suited for local conditions must be ascertained.

The principal advantages of clamps are their low cost and adaptability to a wide range of conditions. They have been used by small farmers in the Andes, by experienced farmers in Europe and large farmers in Argentina.

In clamping, the potatoes are placed in a pile 1 m to 3 m wide at the base and as high as the natural angle of repose of the tubers permit (usually about a third to half the width of the pile). The pile is made as long as necessary to contain the quantity to be stored.

A capacity guide for clamp storage:

Width of potatoes in clamp (m)	1	1.5	2	2.5	3
Capacity per m length (tm)	0.14	0.31	0.56	0.89	1.26

The potatoes are piled on a straw bed and as the pile progresses lengthwise it is covered with a layer of compacted straw about 15 cm to 20 cm thick. Long, unbroken straw is preferable and it is placed in a thatch-like manner. Depending upon climate, the clamp can be left in this condition or at a later stage can be covered with a layer of soil from 15 cm to 30 cm thick for added insulation against frost. The soil layer should not be heavily compacted. In some regions a second straw and soil layer has been advantageous. In some hotter areas additional straw or inverted corn stalks with no soil layer have given best results (Figure 19-A). Plastic sheets have been incorporated into the structures; however, the plastic considerably increases risks of water condensation on the tubers, restricts ventilation and promotes overheating.

In warmer climates clamps should not be more than 1.5 m wide and should have increased ventilation. Large circular high mounds should not be used in warm climates. Ventilation to the clamps may be enhanced by placing ducts under the potato piles (Figure 19-B). If a soil cover is used several chimney type air outlets may be provided in the top of the pile. Basal ventilators may be of simple wooden construction or of bamboo, for example. Ventilators can be triangular or square in cross-section or consist of a well perforated tube. The chimneys may be of any suitable material, but avoid construction that permits rain to enter the clamps. In some situations forced draft ventilation can be applied to clamps by placing a fan at one end of the basal ventilators.

Excessive losses in clamps usually result from rotting as a result of rain penetrating the units. If tubers are to be stored beyond the period of their natural dormancy, chemical sprout inhibitors will be required.

Many modifications of this clamp storage system including types of pits and piles have been developed in different locations.

Multipurpose and Adapted Buildings

Multipurpose and adapted buildings are common structures used for storing potatoes, particularly in potato producing areas of developing countries.

A multipurpose building must accommodate other uses and this reduces its effectiveness for potato storage. However, the system may be the most appropriate and efficient when the whole farming operation is considered. In many potato producing regions, capital is not available to construct and effectively operate specifically constructed stores. This is one reason for multipurpose storage facilities. Storage and handling requirements of agricultural products vary considerably which means that multipurpose storages must involve considerable compromise in design and management to avoid excessive storage losses of individual commodities. Multipurpose storage buildings range from use of upper and lower floors of country dwelling houses, through general warehouses, to multipurpose cold stores. Adapted buildings vary in technical performance depending upon the degree of efficiency of the adaptation, especially in terms of insulation and appropriate and efficient ventilation. They are always less effective than buildings constructed specifically for potato storage.

Figure 19. Small potato clamps (CIP, Huancayo, Peru). A -- Clamp covered with straw and corn stalks. B -- Straw and soil covered clamp with basal ventilating duct.

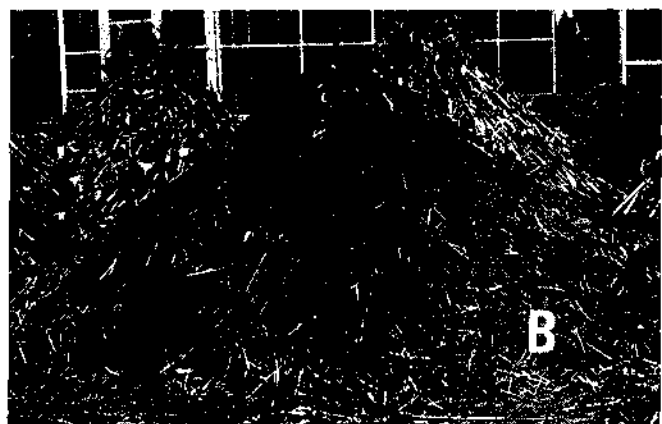

Purposely Constructed Potato Stores

One of the first decisions in planning construction of a structure specifically for storing potatoes is size. Size is based on how many potatoes will be stored. This could be a single building, or a series of similar buildings. Each building may consist of a single room, or have a series of rooms. Each room should have the capacity for one week's harvest. This will aid in management of curing, receiving and shipping.

Size of rooms will depend on how potatoes are stored: in bulk, in boxes or in sacks.

Each 1 TM of tubers stored in bulk occupy about 1.5 m^3 to 1.6 m^3 . Where only natural convection ventilation is used, the tuber pile should not exceed 2.0 m in height to avoid excessive temperature differentials in the pile. In warmer climates reduce pile height to about 1.3 m. At this pile height storage capacity is approximately 0.85 TM per square meter of floor area. With forced draft ventilation coupled with refrigeration a pile depth of 3.5 to 4.0 m is suitable. The walls of a store should be at least 1 m higher than the intended height of storage.

The most useful storage containers are 1/2-ton or 1-ton bulk boxes (Figure 20). Such boxes require mechanical handling. They are particularly useful when various crops are centrally stored together. Table and seed potatoes are commonly stored in jute (burlap) or other types of sacks. Sacks offer little or no advantages over bulk or box storage. If sacks must be used they should be carefully selected and stacked to facilitate ventilation and air movement between and into the

Figure 20. Bulk boxes.

1/2 ton (500 kg) about 0.8 m^3

1 ton (1000 kg) about 1.6 m^3

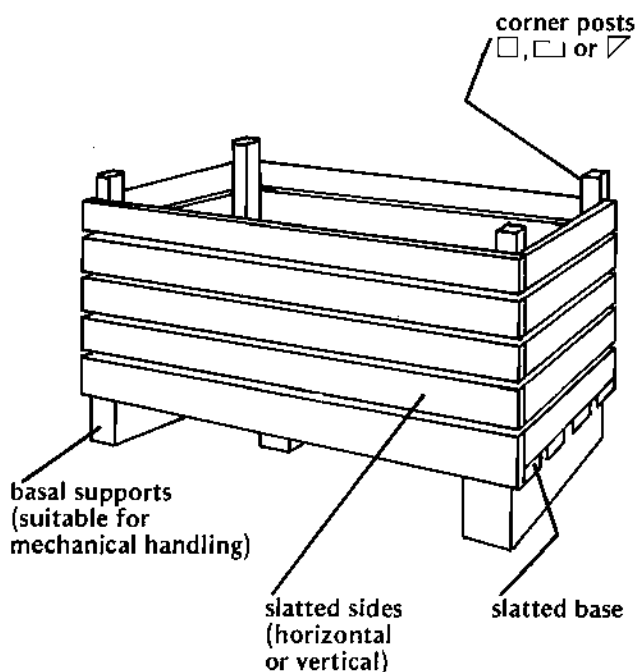

sacks. Light material with a more open mesh is preferred to heavy, closely woven sacks, although the latter type including rice straw sacks are useful for transporting tubers from field to store as they help to reduce handling damage. Wherever containers of any kind are used or re-used they must be clean to avoid spread of disease or insects (see Appendix A5 for suitable disinfectants).

Once the size of storage has been determined the store can be designed. Specific design will depend on local experience and availability and costs of materials. An important design consideration is the ratio of surface area to volume as this will affect the level of heat transfer. The shape with the most favorable ratio is a sphere and the most practical building shape is a cube. Where large storage buildings are required technical limitations on height of tuber piles and economic limitations on the cost of broad span buildings force a compromise between ideal shape and practical possibilities.

Access to both the store site and into the building itself is an important design consideration. Doorways into a store must be large enough to permit easy loading and unloading and in large stores access must be available to individual compartments. The principle of "first in - first out" should always apply. This usually requires multiple access.

Purposely constructed stores range from low-cost small rustic stores (Figure 21) through intermediate types, semi-subterranean or above-ground naturally ventilated stores (Figures 22 and 23) to large scale sophisticated forced draft and refrigerated stores (Figures 24 and 25).

The engineering aspects encountered in the design, construction and management of such stores are considered in the following chapter.

Seed Storage Methods

Seed storage requires special attention to provide seed tubers of acceptable quality and physiological condition at planting time.

Seed storage methods and management must provide the desired development of sprouts prior to planting in terms of both number and size. The number of sprouts per tuber, which determines the number of main stems per plant, is influenced by variety, tuber size, and degree of apical dominance. The degree of apical dominance (Figure 26) in a given variety is influenced by storage conditions, especially by temperature.

Seed potato stores should be designed and managed to produce the optimum number of main stems and optimum number and size of potatoes.

If a potato tuber is stored at a temperature that promotes a short dormant period, the young buds at the apex start growing while growth of the older buds is suppressed. This is known as apical dominance. A tuber with apical dominance has few main stems. As a result of apical dominance a smaller number of tubers may be formed and they may grow too large for proper market size. If storage of seed tubers is controlled to suppress



Figure 21. Simple, small rustic stores with outside painted white. A -- Timber construction, 1.5 TM capacity (CIP, Huancayo, Peru). B -- Lath and plaster and mud brick construction, 2 TM capacity (Mountain State Agricultural College, Baguio, Philippines).

Figure 22. Semi-subterranean store. A -- Supported roof. B -- Self-supporting "A"-frame roof. (From *Idaho Potato Storages*, Bulletin 410, Agricultural Experiment Station, College of Agriculture, University of Idaho, Moscow, Idaho).

A - Supported roof

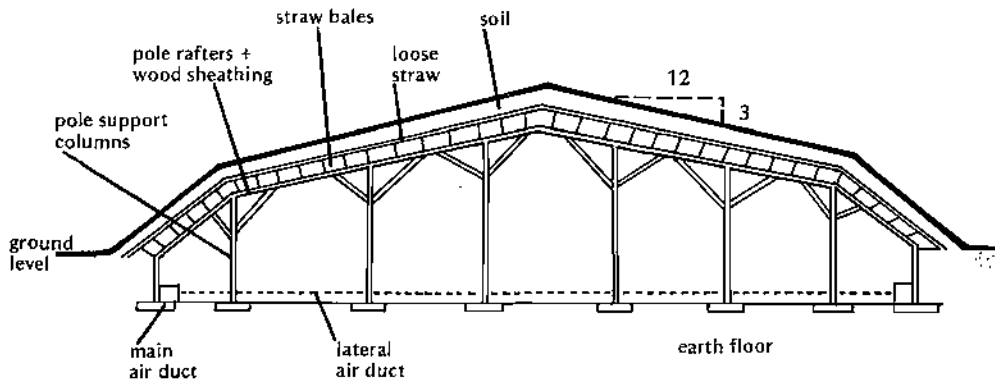

B -- Self-supporting "A"-frame roof

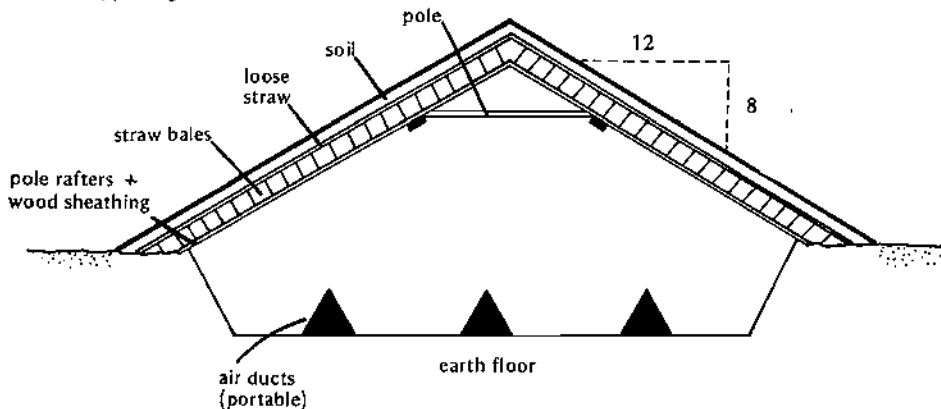

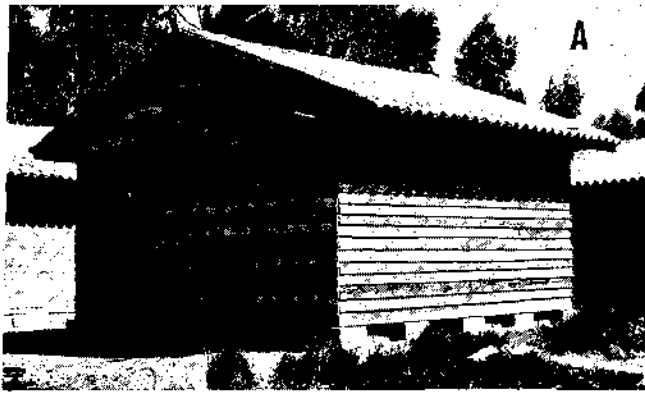

Figure 23. Simple naturally-ventilated stores. A -- Timber, 20 TM capacity (CIP, Huancayo, Peru). B -- Mud-brick or concrete block, 15 TM capacity (CIP-PCARR-MSAC, Baguio, Philippines).



Figure 24. Above-ground large-scale stores. (From *Bulk Potato Storage*, Agriculture Canada Publication 1508, Canada Department of Agriculture).

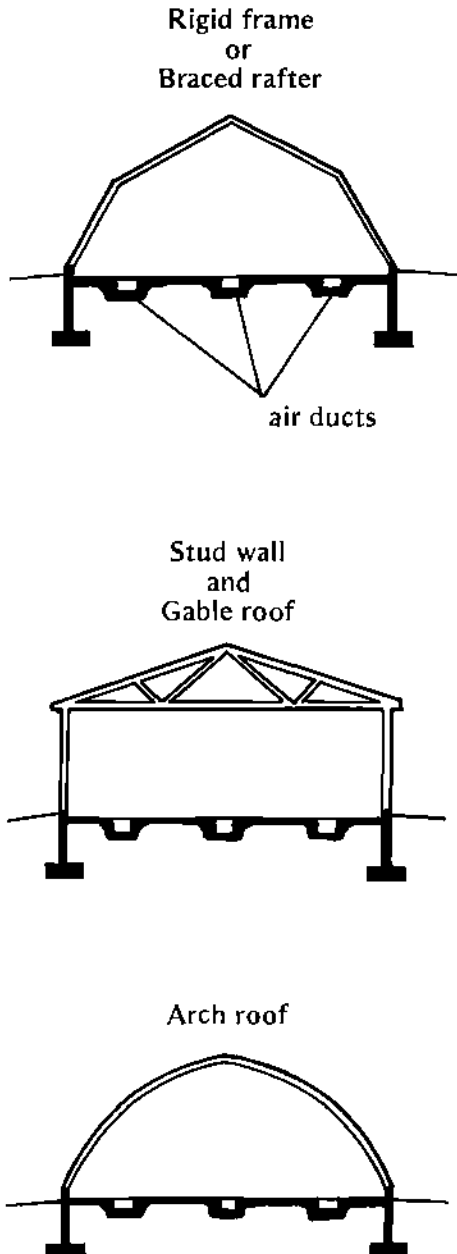
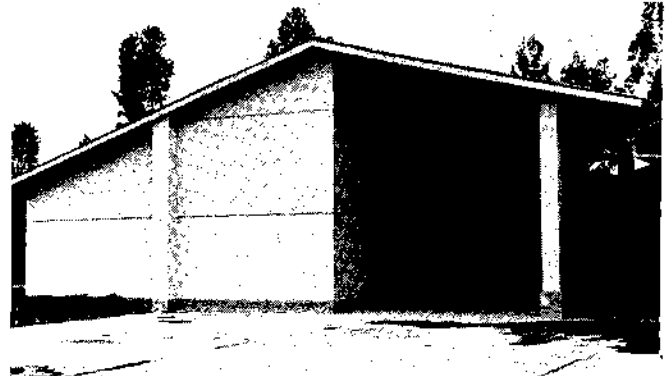

Figure 25. Medium-scale forced draft seed store (CIP, Huancayo, Peru).



apical dominance then the proper number of main stems, usually three to five, will develop. This permits the proper amount of seed to be planted to yield the maximum amount of tubers of suitable market size.

Several methods of storing tubers result in the three to five main stems per planted tuber. One way is to hold the seed at about 4°C temperature to beyond the end of natural dormancy of the variety and until a few weeks before planting. Then store in light (natural or artificial) at about 15°C to provide multiple green sprouting.

Where manipulation of storage temperature is impossible, apical dominance may be manually controlled. After storage at uncontrolled, fairly high temperatures, sprouts begin to grow following the end of the variety's natural dormancy period. The degree of apical dominance/number of sprouts produced will largely depend on the variety. In varieties which show strong apical dominance this may be destroyed by removing the apical sprouts by hand. This promotes many other eyes to sprout but may result in excessive weight loss during storage.

Another method to "break" apical dominance is to cut the potato into two or more parts, each part producing seed pieces with reduced apical dominance. If the tuber is too small to produce two or more seed pieces, simply cut about half way

Figure 26. Apical dominance

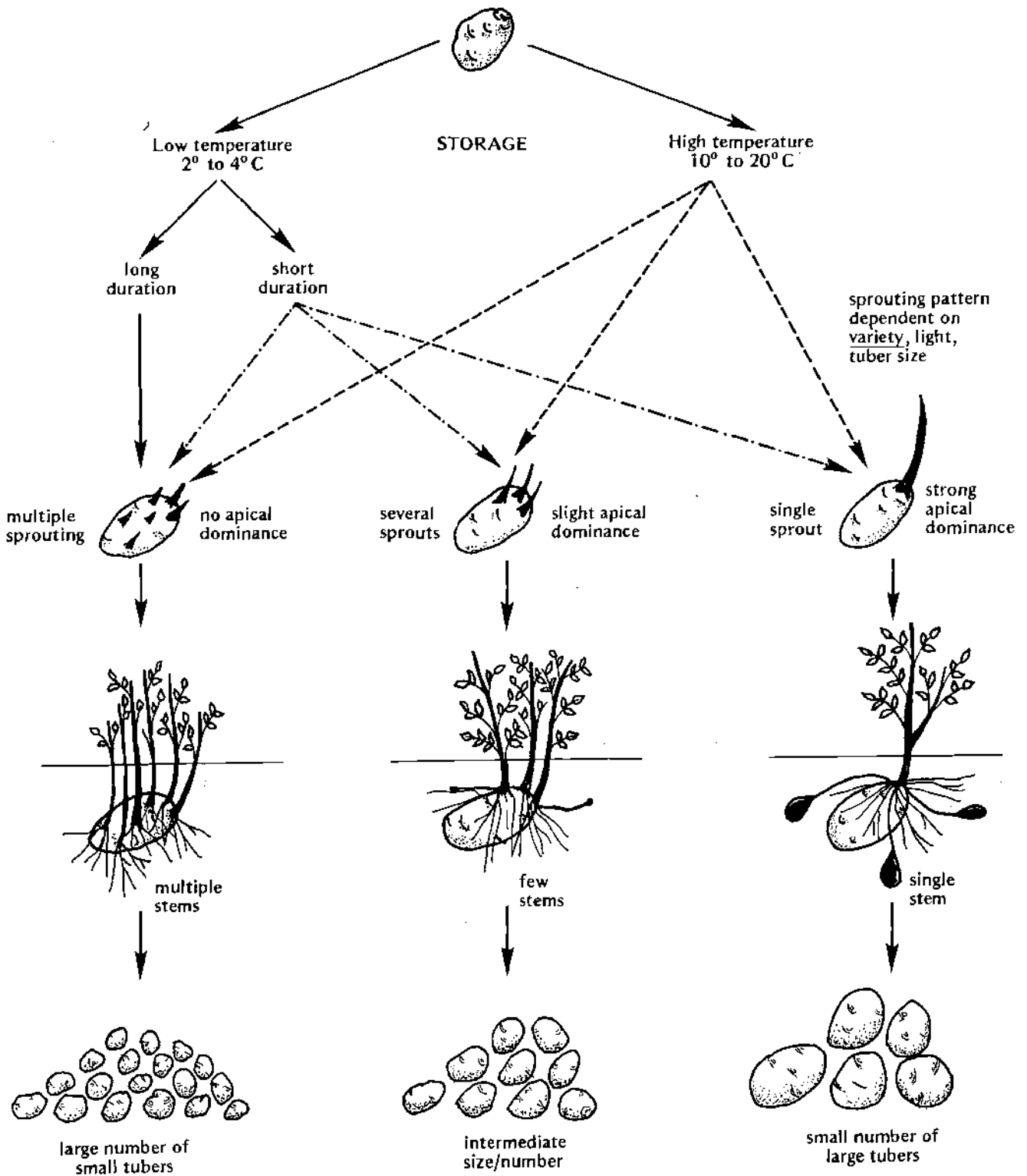

NOTE: Effect on total yield depends on planting density, soil fertility, growing conditions.



Figure 27. Effect of light storage (left) vs dark storage (right) on apical dominance and sprout number.

through it. This also breaks apical dominance and results in additional main stem sprouts.

In the above methods of desprouting or cutting, weight loss of the stored tubers is increased and spread of tuber-borne disease is more likely.

Another way to reduce apical dominance is to store seed tubers in diffused light, either artificial or natural (Figure 27).

Figure 28. Seed tubers stored on simple slatted shelves in natural diffused light store. This store is constructed over an irrigation canal to enhance the storage environment. (Farmer Co-op, Barranca, Peru).



To some extent, use of diffused light replaces the need for low temperature storage of seed tubers and the technique has been used in a wide range of environments. Additional advantages of diffused light storage over dark storage, beyond control of sprout growth, are a reduction in apical dominance, increase in sprout number and increased resistance to several pests and diseases due to tuber greening.

Use of natural diffused light influences considerably the design and construction materials of the storage building. In purposely-built natural diffused light stores entrance of diffused light through transparent walls is ideal because of improved light distribution and for the reason that heat gain into buildings per unit area is greater through the roof than through walls. Where broad-span existing buildings are modified for use as natural diffused light seed stores, sky-lights take full advantage of space with the penalty of increased heat gain. In small scale natural diffused light stores with a capacity of up to 5 to 6 tons, seed tubers can be stored on slatted shelves or in seed trays to a maximum depth of 2 to 3 tubers to permit light access to all tubers. Spacing between shelves and seed trays is largely determined by the width of the building: additional spacing is required to allow good light penetration in wider buildings. In small stores with a width of 1.5 m a spacing of 25 cm between shelves is suggested. Within larger stores individual shelves should not exceed 1.5 m in width to avoid handling difficulties. Approximately 75 kg to 100 kg of seed tubers may be stored per square meter of shelving.

In large capacity natural diffused light stores seed tubers can be stored either on various arrangements of slatted shelves (Figure 28) or in stacked seed trays (Figure 29). Seed trays or shelving add considerably to the cost of storage. However, seed trays have many advantages in reducing tuber handling and are particularly useful where many varieties are involved. Generally, construction costs of diffused light stores are low, but the cost of shelving or seed trays can be a major factor in determining the economics of this simple storage method. Natural diffused light seed storage is a system ideally suited for small-scale farmers. Where larger quantities of seed tubers are stored -- in excess of 100 tons -- the cost of shelving or seed trays and the cost of the additional space required may equal or exceed the cost of more sophisticated low temperature bulk storage methods.

In natural diffused light stores optimum light penetration is obtained in long narrow buildings. Depending on total capacity required and available space, these may be constructed as single long or multiple side-by-side units. Construction materials depend on local availability, costs and climate. A simple frame of round timber or bamboo over a leveled earth floor is recommended. The roof should be well insulated with large overhangs to provide shading for the walls and to prevent direct sunlight from falling on the stored tubers for prolonged periods. Thatch roofs are ideal for this purpose. Transparent walls can be of either wire, nylon or plastic open mesh screening or of poly-

Figure 29. Seed tubers stored in thin layers in stacked seed trays in a natural diffused light store (CIP, Huancayo, Peru).



Figure 30. Spraying to control aphids in a diffused light seed store (CIP, Huancayo, Peru).

thene or rigid and corrugated plastic or glass-fiber sheets. Spaced poles or timber, cane or bamboo may also be used. Polythene or rigid plastic or glass-fiber sheets are appropriate in cool regions, but when used adequate ventilation is needed. If potato tuber moth is a storage problem insect-proof nylon, plastic or wire screen is recommended. Chemical control of aphids is recommended in all seed tuber stores, either diffused light type or reduced temperature in the dark type (Figure 30).

Figures 31 and 32 illustrate a range of sizes and construction in use of natural diffused light seed stores.

Where internal storage temperature can be partly controlled, although not low enough to fully control sprout growth, artificial light may be used to advantage. Best artificial light use is by suspending vertically or supporting fluorescent light tubes between stacks of seed trays (Figure 33). At higher storage temperatures and for longer storage durations more lights are required to give the same degree of control over sprout growth. Under any given storage condition with a given variety, the number of lights required is a compromise between cost and availability of management time. Ideally lights would be placed in

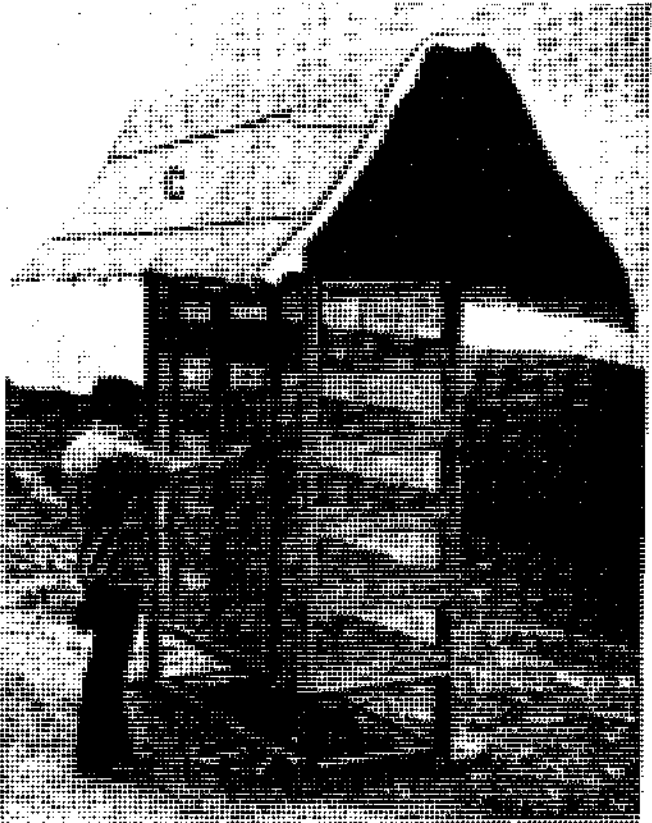
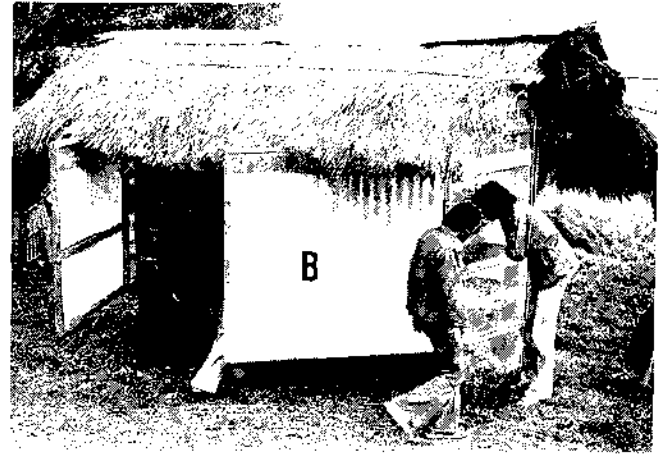
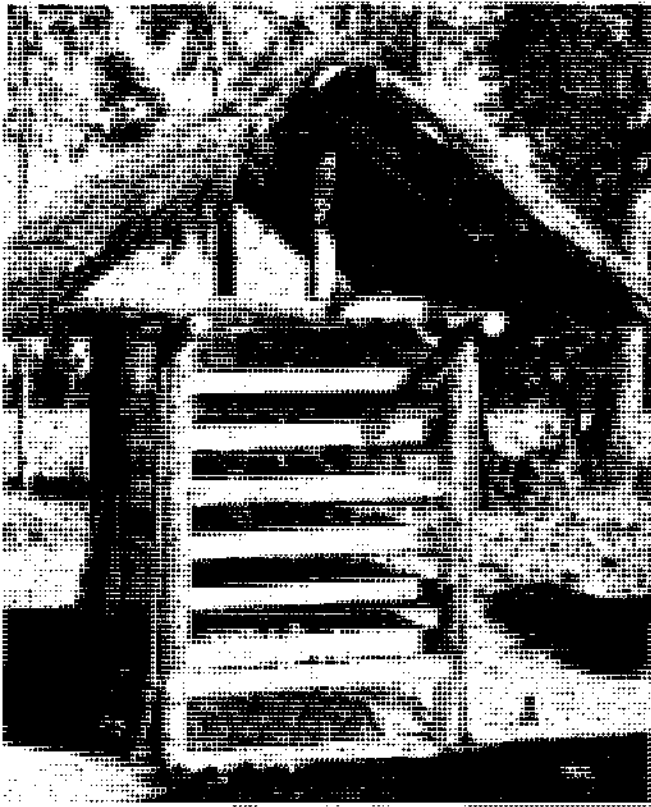

Figure 31. Small-scale natural diffused light stores using fixed shelves and local building design and materials. A -- CIP, Huancayo, Peru. B -- Sayangan, Philippines. C -- Nigale, Nepal.

narrow gangways, one for every two stacks of seed trays. This would be very expensive and by moving the light along the gangway daily one moving can be used for 6 to 10 stacks. Less frequent movement of lights will increase the number required. Where artificial lights are used they should be wired so that if transformers are needed they can be placed outside the storage chamber to keep heat gains to a minimum.

Certain potato varieties tend to produce an excessive number of main stems resulting in formation of too many tubers for a sufficiently high proportion of them to grow to a desired size. In such varieties, one aim of seed storage is to reduce the number of stems. This is done by encouraging apical dominance through storage at about 15°C until the required number of apical sprouts are 1 cm to 2 cm long followed by storage at 4°C to prevent further sprout development prior to planting.

In addition to sprouting, other physiologically aging processes occur during tuber storage. These processes are influenced by storage conditions, mainly temperature. Generally, seed becomes physiologically older with increasing day degrees. Physiological age of seed at planting time affects the subsequent performance in terms of earliness and yielding potential. When an early crop is a major requirement, then physiologically old seed with well developed sprouts should be used. When a longer growing period is available and from which maximum yields are desired, then physiologically young seed should be used (Figure 34).

Improving Storage Methods

Current storage practices must be known and understood before attempting changes or improvements. Prevailing systems, usually developed through experience over a length of time, probably have valid reasons for certain requirements. Any improvements or changes in the storage part of the total system must be evaluated against existing practices not only at the research or experiment station level, but also at the end-user level as part of the total production-storage-demand system. There are three levels in this total evaluation process: (1) technical, (2) economic, and, (3) acceptability.

Technical evaluation compares the technical performance of the improved with the existing storage method. In the case of stores for consumer potatoes this means comparing storage losses. With storage of seed tubers both storage losses and

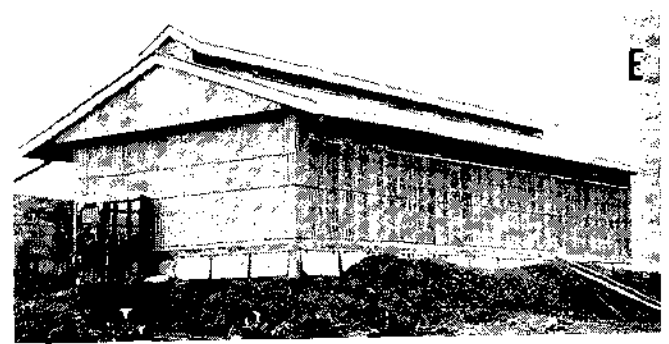
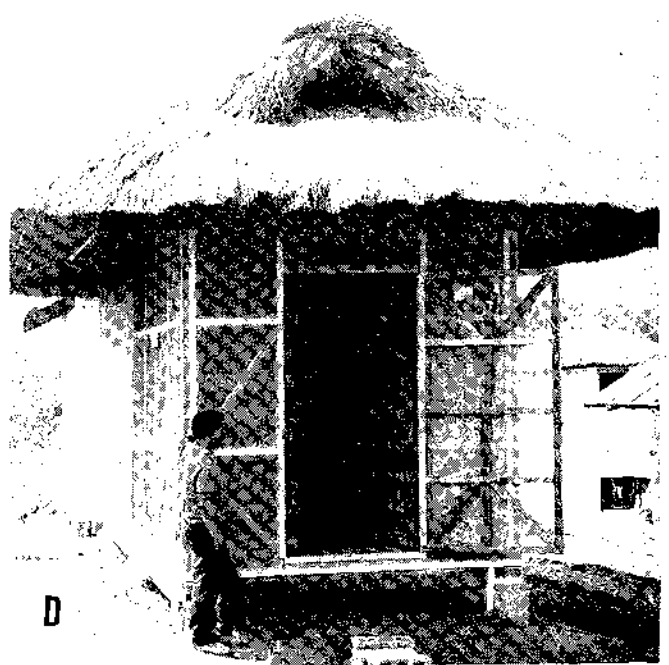
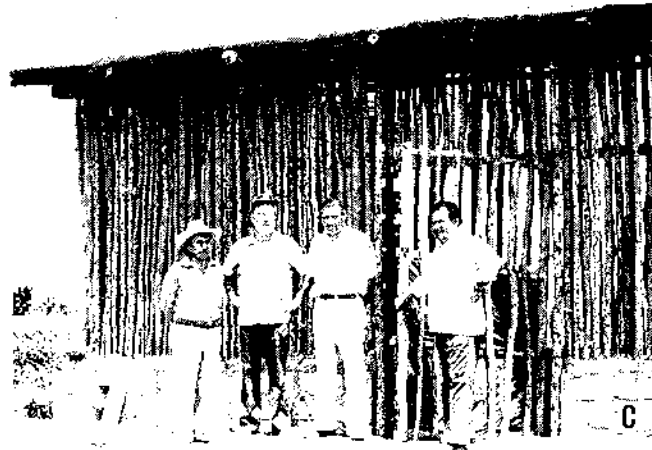

Figure 32. Larger scale natural diffused light seed stores using fixed shelves or seed trays in a building of local design and materials. A -- CIP, Huancayo, Peru (10 to 15 TM capacity). B -- CIP, San Ramon, Peru (8 to 10 TM). C -- Farmers cooperative, Barranca, Peru (12 to 15 TM). D -- Mountain State Agricultural College, Baguio, Philippines (10 to 12 TM). E -- Farmers cooperative, Benquet, Philippines (90 to 100 TM).

Figure 33. Use of artificial light in Forced Draft Ventilated seed store (CIP, Huancayo, Peru).

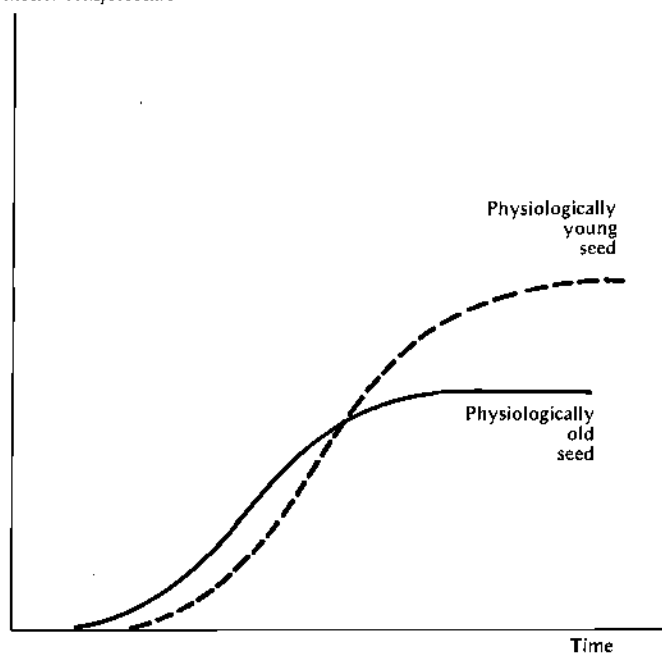

Figure 34. Effect of physiological age of seed on yields.

subsequent performance of the seed in the field must be evaluated. Such evaluations are initially made at the experiment station but ultimately must be part of the total system at farmer or end-use level.

Economic evaluation compares cost benefits of "improved" and existing systems. This must be in the context of the total production-storage-demand system, including such factors as cost and availability of differing capital requirements, construction costs, running and maintenance costs, labor costs and availability, and interest charges. In economic evaluations cash flow problems and requirements for available cash at fixed times of the year can be overriding economic factors in many situations. An example of a methodology for technically and economically comparing seed storage systems is provided in the Appendix A6.

Acceptability evaluation is important because if the "improved" system is not accepted and used, expounding the technical and economic merits of the system is not justified. Knowledge of socio-economic factors influencing changes in a given society will be useful in judging the potential acceptability of any technology. Wherever possible the adoption of new systems should be monitored. This is best achieved in cooperation with locally knowledgeable social scientists.

Knowing and understanding these three levels of evaluation helps design meaningful problem-

solving research programs and is essential for transfer of technology or extension programs that suggest or recommend changes.

Unfortunately, many examples show that only the first or second levels of evaluation were considered and applied often resulting in technically and possibly economically sound storage structures remaining empty and unused. The storage system must be acceptable to both the production and demand parts of the system in addition to the user or it will not be used effectively.

Technical improvements in consumer potato storage often involve ventilation and insulation. Insulation of existing buildings used to store potatoes may be improved with low-cost, locally available materials. Insulation capability of most materials is reduced when they are wet. Heat absorption (and thus insulation needs) in many situations may be reduced considerably by painting the external building surfaces white. A full understanding of psychrometrics and the optimal ways of removing heat from potatoes by efficient air distribution often leads to simple improvements in ventilating systems.

In seed potato stores, improvements may be of both insulation and ventilation or may involve use of diffused light as discussed elsewhere in this publication. If either the external environment is not suitable or capital is not available for controlled temperature storage of seed tubers, storage in natural diffused light in simple low cost structures offers many advantages over conventional simple storage in the dark. The scale to which natural diffused light can be economically applied will depend on local costs, production, distribution and demand systems. In general, it is a technology particularly suited to the smaller scale farmer who wishes to store his own seed. The size of required individual seed storage facilities is very much influenced by prevailing seed production, distribution and marketing patterns. Traditionally where improved or certified seed is usually centrally stored and sold and distributed at planting time, very large storage facilities are required. In such large facilities storing hundreds or even thousands of tons, use of natural diffused light is not appropriate and sophisticated temperature control systems are required. Alternatively, and assuming the pricing system is sufficiently flexible, the seed could be sold and distributed to users at harvest time. This would mean that the same total quantity of seed tubers would need to be stored in a large number of smaller stores at the farm level. In such circumstances and also where home produced seed is being stored on the farm, simple natural diffused light stores are commonly appropriate.

STORAGE ENGINEERING

Introduction

Retention of tubers

Weather protection

Insulation

Terms and symbols

Calculation of (U) values

Vapor barriers

Psychrometrics for Potato Storage

Psychrometric properties

Psychrometric charts

Calculation of cooling requirements

Calculation of ventilation requirements

Ventilation Systems

Ambient air ventilation

**Natural convective
ventilation (NCV)**

**Forced draft
ventilation (FDV)**

Ventilation with artificially cooled air

Evaporative cooling

Refrigeration

Humidification systems

Air Distribution

Resistance to air-flow

Size and distribution of ducts

Recirculation

Inlet and exhaust openings

Fan choice

STORAGE ENGINEERING

Introduction

Once the size and shape of a store have been determined, attention centers on details of construction. A structure for potato storage has three major requirements:

- Retention of the potatoes,
- Protect them against weather, and
- Temperature and humidity control within the building.

Storing potatoes in structures constructed of locally available building materials we must consider costs and insulating values of the materials. The floor, walls, ceiling and roof must be considered part of the temperature control system and so insulating values become part of cost evaluations.

Control of storage temperature and humidity require an understanding of the thermodynamic properties of air (psychrometrics).

From an understanding of psychrometrics together with a knowledge of the desired internal and existing external environmental conditions and store characteristics, the requirements for obtaining and maintaining the desired storage environment can be determined. This involves a calculation of cooling requirements. From this requirement decisions on ventilating systems can be made. Once the type of ventilating system to be used has been selected the most appropriate means of distributing the ventilating air through the stored tubers to obtain and maintain the selected storage conditions can be selected and designed.

Retention of Tubers

The floor must support potatoes which should be considered as having a mass of 641 kg/m^2 per meter of depth. If potatoes are piled 4 meters deep (as with forced draft ventilation or refrigeration), then the floor must support 4×641 or $2,564 \text{ kg/m}^2$. Additionally, the floor must be slatted or provided with ducts to permit passage of ventilating air.

With potatoes stored in bags or in boxes, the total pressure is on the floor. When potatoes are stored in bulk, a considerable portion of the weight is against the walls. The walls must be strong enough to retain this pressure thrust.

For calculating pressure on the walls, the bulk potatoes can be considered as a fluid. The "density" of this "fluid" can be calculated by use of Rankines formula.

The angle of repose of potatoes varies between 30-40 degrees with 35 degrees an average for unsprouted tubers. When tubers are stacked against a vertical wall, the weight of the wedge of potatoes, which would otherwise slide down the

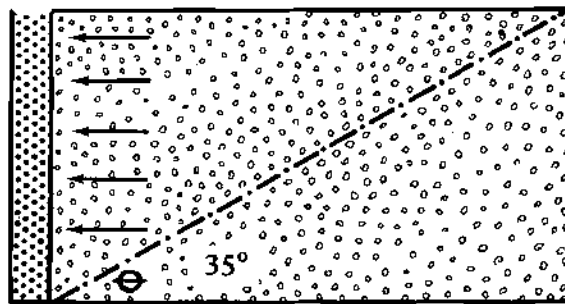

Figure 35. Angle of repose of potato pile. (From *Storage Buildings*, Part 1, Potato Marketing Board, Sutton Bridge Experimental Station, Report No. 6, London).

natural slope of the stack, exerts a pressure on the wall (Figure 35). The magnitude of the horizontal pressure may be calculated by Rankines formula:

$$p = \frac{wh(1 - \sin \theta)}{1 + \sin \theta}$$

where p = horizontal pressure exerted by the stack in kg/m^2 at h meters below level fill surface
 w = weight of potatoes in kg/m^3 (641 kg/m^3)
 h = distance below top level fill in meters
 θ = natural angle of repose

e. g.

when angle of repose = 35°

$$\frac{1 - \sin \theta}{1 + \sin \theta} = \frac{1 - 0.57}{1 + 0.57} = \frac{0.43}{1.57} = 0.27$$

therefore, p at 1 meter depth below surface of stack

$$= \frac{641 \text{ kg}}{\text{m}^3} \times 1 \text{ m} \times 0.27$$

$$= 173 \text{ kg/m}^2$$

and p at 2 m depth below surface of stack

$$= \frac{641 \text{ kg}}{\text{m}^3} \times 2 \text{ m} \times 0.27$$

$$= 346 \text{ kg/m}^2$$

The pressure diagram against a vertical face (Figure 36) is triangular in shape with its center of thrust at the center of gravity, i. e. one third of the height from the base. If the wall is 3 m high, maximum pressure at the base will be $641 \times .27 \times 3 = 519 \text{ kg/m}^2$. The total pressure exerted on the wall acts at a point one third up the wall at the center

Figure 36. Pressure against wall. (From *Storage Buildings*, Part 1, Potato Marketing Board, Sutton Bridge Experimental Station, Report No. 6, London).

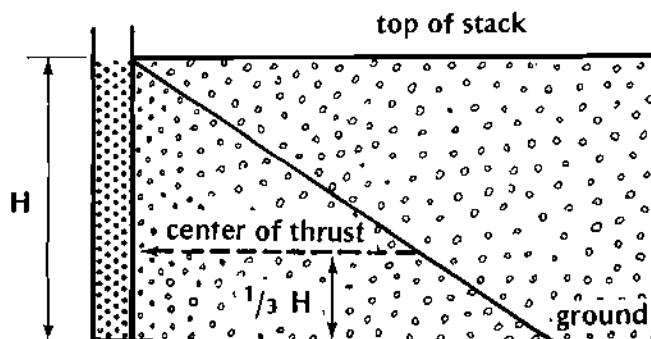

of "thrust." Its value is represented by the area of the triangle having base equivalent to maximum pressure and height equivalent to total depth.

i. e.

$$p = 1/2 (\text{base} \times \text{height})$$

$$p = 1/2 (519 \times 3) = 774 \text{ kg per meter length of wall with the force acting at } 1/3 \text{ of the height, i.e. } 1 \text{ m up the wall.}$$

Frame stanchions must be designed to carry this thrust translocated from the retaining wall. This is normally achieved by increasing the dimensions of the frame.

The above calculation is based on an average angle of repose and does not allow for "bridging." "Bridging" occurs when potatoes settle during storage. Some of the vertical weight thrust is changed to a horizontal thrust. In effect, the angle of repose becomes smaller, and may be only 30°. The calculation then becomes as follows:

$$\frac{1 - \sin 30^\circ}{1 + \sin 30^\circ} = \frac{1 - .50}{1 + .50} = 0.33$$

At: one meter depth, $641 \times 1 \times .33 = 212 \text{ kg/m}^2$
 two meters depth, $641 \times 2 \times .33 = 424 \text{ kg/m}^2$
 three meters depth, $641 \times 3 \times .33 = 636 \text{ kg/m}^2$

therefore $p = 1/2 (636 \times 3) = 954 \text{ kg per meter length of wall acting at a point of } 1/3 \text{ of the wall height.}$

Local experience should determine the exact angle of repose to be used in such pressure calculations. For the proper and safe design of walls for bulk potato stores a professional engineer should be consulted.

A properly designed storage will have a ceiling above the stored potatoes. This ceiling in NCV or FDV can be 15 cm to 30 cm of loose straw supported by wire mesh. This will not hinder the free exit of warm air from the stored potatoes or the entrance of cool air beneath and through the slatted floor while still providing adequate insulation. Another function of the straw is to exclude light from the potatoes.

In a refrigerated storage the ceiling must be solid and constructed to permit recirculation. It must have sufficient insulation for protection of heat gain or heat loss. In all cases the ceiling should be at least one meter above the height of the potatoes.

The roof serves only to protect the store against sun and other elements (wind, snow and rain). It should project or have sufficient overhang to protect the walls against excess sun. Heat gain per unit of roof area can be double that of the wall area. Although potatoes are further protected from heat gain by the inside ceiling some roof insulation is recommended.

Weather Protection

Protection against weather requires exterior surfaces of the roof and walls to be weatherproof

against rain and wind, and, in the case of consumer potatoes, protection against light. In areas of high solar radiation, a light-colored building will help reflect this solar energy. As shown below a building painted white can have an outside wall temperature 10° to 20° C below that of a dark-walled building.

Effect of White Paint on the Temperature of Simple Wooden Stores, Huancayo, Peru.

Temperature (°C) (Average of 5 Days)

Time (hrs)	External surface		Internal surface	
	Natural	White	Natural	White
0800	2	2	2	2
0900	23	15	8	4
1000	32	22	15	8
1100	37	24	17	10
1200	42	25	22	14
1300	44	28	24	15
1400	46	32	25	15
1500	20	17	19	15
1600	20	17	19	14
Ave	29.6	20.2	16.8	10.8

In this case, natural color wooden walls would need to be 5.0 cm thick to have the same insulating value as white painted wooden walls 2.5 cm thick under conditions of this experiment at Huancayo, Peru. Under these circumstances the white paint was equivalent to an extra 2.5 cm thickness of wood.

Commonly used weather protection materials (sheet metal, corrugated plastic or asbestos/cement) have poor insulation values, and additional insulation is necessary.

Insulation

Good insulation is a requirement for all potato stores. It is as important where natural ventilation with outside air is the only means of controlling store temperature as for a refrigerated type store. Based on an ideal inside temperature of 5° C, potato stores should be insulated to a (u) value of

$$\frac{2.34 \text{ kg}}{\text{hr} \times \text{m}^2 \times \text{c}} \left(\frac{0.6 \text{ watts}}{\text{m}^2 \times \text{c}} \right)$$

Side wall and ceiling insulation in potato stores is to make environmental control possible. Insulation must be used (1) to minimize heat transfer into and out of the store (this minimizes temperature fluctuations), and, (2) in some cases to eliminate condensation within the store.

During periods of temperatures below about -5° C, heat flows out through the side walls and ceiling. This heat loss beyond the limited amount of respiration heat produced by the potatoes must be supplied by supplemental heating. This means added costs for fuel.

During periods of high outside temperature, heat flows into the structure resulting in higher storage temperature. To compensate for the higher temperature extensive use must be made of naturally available or refrigerated cool air. This will increase storage costs. Condensation occurs when heat loss results in the interior air being cooled below its dew point. If this condensation occurs on the ceiling or walls and drips back onto the stored potatoes, the resulting decay can cause serious losses.

Terms and Symbols

Certain terms and symbols are used to define the thermal properties of building materials and structures. It is necessary to understand these before attempting to calculate thermal insulation values for individual materials or composite structures.

Thermal Conductivity (k). The thermal conductivity of a material is a specific property of that material and is defined as the quantity of heat (heat flow) in *joules* flowing through 1 m² of the material, 1 meter thick, in one second when there is 1°C temperature difference between the faces. The units of (*k*) are expressed in

$$\frac{\text{watts or,}}{\text{m} \times \text{°C}} \quad \frac{\text{joules}}{\text{sec} \times \text{m} \times \text{°C}} = \frac{3.6 \text{ kj}}{\text{hr} \times \text{m} \times \text{°C}}$$

The lower the (*k*) value of a material, the better its insulating efficiency. The (*k*) value increases if the material becomes damp because water is a good conductor of heat. Therefore, to obtain the maximum insulating efficiency from a material it should be kept as dry as possible. Some (*k*) values for common materials are listed in Appendix A2.

Thermal Resistance (R). Thermal resistance is a measure of the resistance to heat flow either of a material of any given thickness, or of a combination of materials. It may be regarded as the number of seconds required for the transmission of 1 *joule* through 1 m² when the difference between the inner and outer surface temperatures is 1°C. Thermal resistance (*R*) is expressed in

$$\frac{\text{m}^2 \times \text{°C} \times \text{sec.}}{\text{joule}} \quad \text{or,} \quad \frac{\text{hr} \times \text{m}^2 \times \text{°C}}{\text{kj}} \quad \text{or,} \quad \frac{\text{m}^2 \times \text{°C.}}{\text{watts}}$$

If the thickness of a material is increased, there is a corresponding increase in thermal resistance, and if several materials are placed together in parallel layers the total thermal resistance of the combination may be obtained by adding the resistance provided by the particular thickness of each component.

Thermal Transmittance (U). The (*U*) value is defined as the quantity of heat in *joules* which will flow through 1 m² of structure in one second when there is 1°C temperature difference between the air on each side. The units of (*U*) are

$$\frac{\text{watts}}{\text{m}^2 \times \text{°C}}, \quad \text{or} \quad \frac{\text{j}}{\text{sec} \times \text{m}^2 \times \text{°C}}, \quad \text{or} \quad \frac{\text{kj}}{\text{hr} \times \text{m}^2 \times \text{°C}}$$

The (*U*) value determines the amount of heating or cooling needed to maintain the desired storage temperatures.

The (*k*) and (*R*) values defined above are related to the temperatures at the surface of the materials. The surface temperatures of a building are not usually known, however, and for the purposes of heat loss calculation it is the inside and outside air temperatures that are used. The heat is first transferred from the inside air to the structure then through the structure and, finally, from the structure to the outside air. Both the inside and the outside surfaces provide some resistance to heat flow and the thermal transmittance, or (*U*) value, should take into account these surface resistances (see Appendix A2).

The (*U*) value may be regarded as the overall air-to-air conductance, which is the reciprocal of the overall air-to-air resistance, i.e. $(U) = \frac{1}{(R)}$.

Calculation of (U) Values

To calculate the (*U*) value of a structure it is necessary to determine the total air-to-air resistance of the structure. This is the sum of the internal and external surface resistances plus the resistance of all structural components and the resistance of any air space.

In other words the (*U*) value depends on three main features:

- (a) a boundary layer of air at the inside face,
- (b) the nature of the wall, and,
- (c) a boundary layer of air outside.

While the thickness of the boundary layer of air in contact with the inside wall surface is virtually constant, that of the outside varies greatly with the wind which passes along the wall. This is often completely ignored when (*U*) values are being calculated. In cases where a wall is only a thin lamina of material, such as asbestos cement sheets, the only real resistance to heat transfer is in the two air layers on the inside and outside of the structure.

To design a new storage it is necessary to make the walls for a specific (*U*) value. If an existing building is to be used, the (*U*) value of the walls must also be known. The following formulas are used in these calculations

(*k*) for the materials being evaluated

$$(R) = \frac{\text{thickness}}{(k)}$$

$$(U) = \frac{1}{\text{thickness}} = \frac{1}{(R)} = \frac{1}{(R_1) + (R_2) + (R_3)}$$

Example 1

Design a store wall. This wall will be composed of a 0.025 m wood exterior wall, an air space and a 0.050 m wood interior wall. How much air space is needed for

$$(U) = \frac{4.0 \text{ kj}}{\text{hr} \times \text{m}^2 \times \text{°C}} ?$$

There is a wind of 5 m/s

$$(k) \text{ air space} = \frac{.43 \text{ kj}}{\text{hr} \times \text{m} \times ^\circ\text{C}} \text{ (from Appendix A2)}$$

$$(k) \text{ wood} = \frac{.54 \text{ kj}}{\text{hr} \times \text{m} \times ^\circ\text{C}} \text{ (from Appendix A2)}$$

$$(R)_1 \text{ ext. wood} = \frac{.025 \text{ m} \times \text{hr} \times \text{m} \times ^\circ\text{C}}{.54 \text{ kj}}$$

$$= \frac{.046 \text{ m}^2 \times \text{hr} \times ^\circ\text{C}}{\text{kj}}$$

$$(R)_2 \text{ int. wood} = \frac{.050}{.54} = \frac{.093 \text{ m}^2 \times \text{hr} \times ^\circ\text{C}}{\text{kj}}$$

$$(R)_3 \text{ Int. surface} = \frac{.061 \text{ m}^2 \times \text{hr} \times ^\circ\text{C}}{\text{kj}}$$

(from Appendix A2)

$$(R)_4 \text{ ext. surface, 5m/s} = \frac{.009 \text{ m}^2 \times \text{hr} \times ^\circ\text{C}}{\text{kj}}$$

(from Appendix A2)

$$(R)_5 \text{ Air space} = ?$$

$$(U) = \frac{4.0 \text{ kj}}{\text{hr} \times \text{m}^2 \times ^\circ\text{C}} = \frac{1}{.046 + .093 + .061 + .009 + (R)_5}$$

$$= \frac{1}{.209 + (R)_5}$$

$$.209 + (R)_5 = \frac{1 \text{ hr} \times \text{m}^2 \times ^\circ\text{C}}{4.0 \text{ kj}}$$

$$(R)_5 = \frac{.041 \text{ m}^2 \times \text{hr} \times ^\circ\text{C}}{\text{kj}}$$

$$(R)_5 = \frac{\text{thickness}}{(k) \text{ air space}}$$

$$\text{Thickness} = \frac{.041 \text{ m}^2 \times \text{hr} \times ^\circ\text{C}}{\text{kj}} \times \frac{.43 \text{ kj}}{\text{hr} \times \text{m} \times ^\circ\text{C}}$$

$$= .018 \text{ m (0.7 inch)}$$

Example 2

How much heat will pass through each square meter of the above wall in one hour when exterior temperature is 25°C and interior temperature is 8°C?

$$(U) = \frac{4.0 \text{ kj}}{\text{hr} \times \text{m}^2 \times ^\circ\text{C}}$$

$$\times \frac{1 \text{ hr} \times 1 \text{ m}^2 \times 17^\circ\text{C}}{1} = 68 \text{ kj.}$$

Example 3

Calculate (U) for a wall of bricks 0.33 m thick, wind of 10 m/s.

$$(k) \text{ bricks} = \frac{2.6 \text{ kj}}{\text{hr} \times \text{m} \times ^\circ\text{C}} \text{ (from Appendix A2)}$$

$$(R) \text{ bricks} = \frac{.33 \text{ m} \times \text{hr} \times \text{m} \times ^\circ\text{C}}{2.6 \text{ kj}}$$

$$= \frac{.127 \text{ m}^2 \times \text{hr} \times ^\circ\text{C}}{\text{kj}}$$

$$(R) \text{ int. surface} = \frac{.061 \text{ m}^2 \times \text{hr} \times ^\circ\text{C}}{\text{kj}}$$

(from Appendix A2)

$$(R) \text{ ext. surface, 10 m/s} = \frac{.005 \text{ m}^2 \times \text{hr} \times ^\circ\text{C}}{\text{kg}}$$

(from Appendix A2)

$$(U) = \frac{1}{(.127 + .061 + .005)}$$

$$= \frac{\text{kj}}{.193 \text{ m}^2 \times \text{hr} \times ^\circ\text{C}}$$

$$= \frac{5.18 \text{ kj}}{\text{m}^2 \times \text{hr} \times ^\circ\text{C}}$$

Example 4

This means that 88.1 kj will pass per hour per m² through the wall when its temperature difference across the wall is 17°C.

Vapor Barriers

The need to keep most insulating materials as dry as possible and to avoid condensation within the storage structure is again emphasized.

Moisture vapor will pass through the structure from a high vapor pressure area to a low vapor pressure area. Because a high relative humidity should be maintained inside a store there is likely to be a vapor pressure gradient across the wall from inside to outside the store. If the materials on the external surface of the wall have a high resistance to water permeability a danger exists that moisture vapor passing through the inner wall surface will be trapped in the insulation material where it may be absorbed into the cell structure of the insulating material. For this reason water permeability of materials used in wall construction should decrease from outside to inside. In many regions of potato storage the day temperature is higher than inside the storage and the night temperature is lower than inside the storage. This may result in a fluctuating vapor gradient. For this reason a vapor pressure barrier (plastic sheeting) should ideally be installed on both interior and exterior walls to protect the insulation.

Psychrometrics for Potato Storage

Introduction

Ambient air is a mixture of dry air and water vapor. Psychrometrics refers to the thermodyna-

mic relationship between the dry air and the water vapor. Understanding psychrometrics is fundamental to the proper design and management of potato stores.

Psychrometric properties

Dry Bulb (DB) is the temperature of the ambient air (dry air plus water vapor) as indicated by an ordinary thermometer. From psychrometric charts (Appendix A3) the Vapor Pressure at saturation at this temperature can be determined. Potato storage dry bulb temperatures range from 2° to 25°C.

Wet Bulb (WB) is the temperature as indicated by an ordinary thermometer with its bulb covered with a moist wick or cloth. The air must blow past the covered wet bulb at a velocity of at least 4 meters per second. Potato storage wet bulb temperatures are 1° to 6°C below dry bulb temperatures. The dry bulb temperature of the ambient air can be lowered to this temperature by proper use of evaporative cooling.

Dew Point (DP). A thermodynamic relationship of DB and WB determined by use of a psychrometric chart. It is the temperature at which condensation of water (dew) occurs when the ambient air is cooled. It is the temperature of saturation for the ambient air being evaluated. Dew Point temperature is needed to determine the vapor pressure of water in the ambient air. DP is usually 0.5° to 5° below WB and can be read from the psychrometric chart. The difference in vapor pressure in this air and in air saturated at DB temperature is called vapor pressure deficit or (VPD).

Specific Volume (Spec. Vol.). This is the volume of the ambient air per unit weight of dry air. Units are cubic meters per kilogram of dry air (m^3/kg dry air). It is determined from (DB) and (WB) by use of the psychrometric chart. In potato storage the variation is between 0.80 m^3 and 0.85 m^3 per kg of dry air.

Humidity is weight of water in the ambient air. Specific Humidity is the kilograms of water in one kilogram of dry air (kg/kg dry air). In potato storage the range seldom exceeds 0.005 kg to 0.015 kg water per kg of dry air.

Relative Humidity (RH) is the ratio of vapor pressure of the water in the air to the vapor pressure of the water in saturated air at the dry bulb temperature. Units are a decimal but usually multiplied by 100 and reported as percent relative humidity (%RH).

Vapor Pressure (VP) is the partial pressure exerted by water vapor contained in the ambient air. Units are bars but usually are reported in millibars. When the air is fully water saturated, this term is also referred to as the saturation pressure at the measured temperature. Vapor Pressure is dependent solely on temperature and specific humidity. VP (saturated) at DB, minus VP (saturated) at DP is the Vapor Pressure Deficit (VPD). Determined from DB and DP of Psychrometric Tables or Charts. (Figure 37)

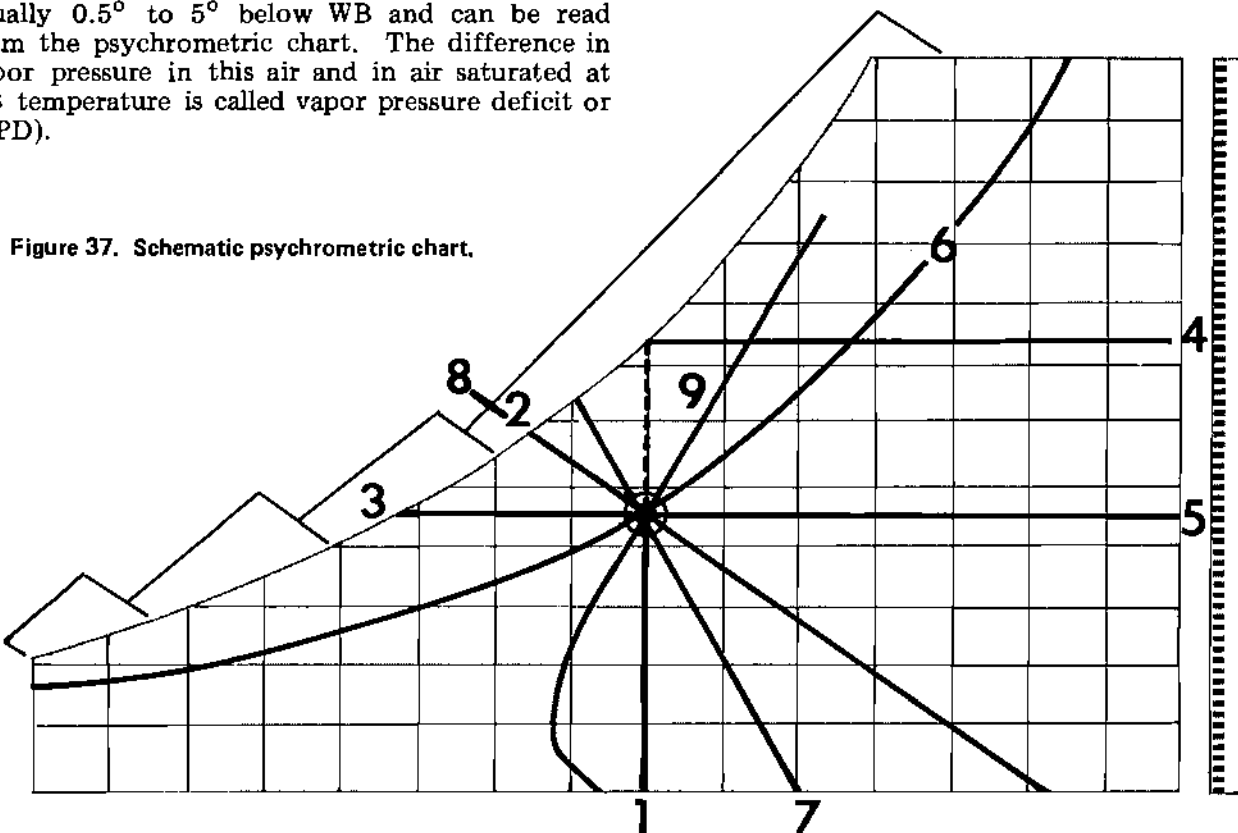

Figure 37. Schematic psychrometric chart.

- | | |
|--|--------------------------------------|
| KEY 1 Dry-Bulb Temperature (DB) - °C | 6 Relative Humidity (RH) - % RH |
| 2 Wet-Bulb Temperature (WB) - °C | 7 Specific Volume - M^3/kg Dry air |
| 3 Dew-Point Temperature (DP) - °C | 8 Enthalpy - kj/kg Dry air |
| 4 Humidity at DB - kg water/kg Dry air | 9 Enthalpy correction. |
| 5 Humidity at DP - kg water/kg Dry air | |

Enthalpy is the heat content of the ambient air per unit weight of dry air. Units are kilojoules per kilogram of dry air (kj./kg. dry air) and is read from a psychrometric chart. Changes of enthalpy are factors to be considered in managing storage temperatures. As air passes through the stored potatoes enthalpy increases by the number of joules picked up from the potatoes. The amount of air with its increase in enthalpy must equal or exceed the amount of heat determined by total cooling requirements.

Psychrometric Charts

The thermodynamic properties are so inter-related that if only two of them are known, the other properties can be calculated. The best way to present these interrelated calculations is with *Psychrometric Charts*. With the aid of these charts, when any two properties are known, the others can be rapidly determined. (The copyrighted charts in Figure 37 and Appendix A3 of this publication are reproduced through special permission of the Carrier Corporation, Syracuse, New York, USA).

Important psychrometric properties for storage of potatoes are illustrated in Figure 37 and include:

Dry Bulb. This is air temperature. If potatoes are at the same temperature as air their physiological behavior can be predicted. DB is a scale usually along the bottom of the chart and the lines run vertically.

Wet Bulb. This is the limit of evaporative cooling. WB is a scale usually along upper left of chart and the lines run downward toward the right.

Dew Point. If the air is cooled, the water vapor will condense into *dew* at this temperature. If the condensed water causes the stored potatoes to become moist, storage disease problems are likely to result. The Dew Point temperature permits us to determine pressure of water vapor in the ambient air. DP is read to the left along a horizontal line from intersection of DB and WB temperatures.

Vapor Pressure Deficit, VPD. Vapor Pressure at DB minus Vapor Pressure at DP. VPD causes dehydration in potatoes by the movement of water from within the tubers to the surrounding air. This property and the Dry Bulb temperature are the most important considerations for storage of potatoes. This VPD is determined from the Tables on psychrometric charts in Appendix A3.

Enthalpy. Change in enthalpy indicates the gain (or loss) of heat units as air passes around the stored potatoes. Enthalpy lines parallel wet bulb line and are read from a scale to upper left of the charts.

Specific Volume. Necessary to determine proper size of fans and ducts in forced air and refrigerated storages. These lines slope sharply from lower right toward upper left of the charts.

The two properties easiest to measure are Dry Bulb and Wet Bulb. A psychrometer is used in which a current of air is drawn uniformly across the dry bulb and wet bulb at a velocity of 4 to 5 meters per second. The battery-operated, aspiration psychrometer is commonly used, especially in field situations.

Example:

See Figure 37 and Appendix A3 (Sea level chart) (Numbers in parentheses correspond to numbers on Figure 37).

(1) DB	20°C
(2) WB	15°C
(3) DP	11.6°C
(4) H at DB0146 kg/kg dry air
(5) H at DP0084 kg/kg dry air
H Ratio0084 ÷ .0146 = .575 (x100 = 57.5%RH)
Sat. VP at DB (20°C)	23.09 mbars (from tables in Appendix A3)
Sat. VP at DP (11.6°C)	13.51 mbars (from tables in Appendix A3)
VPD	23.09 – 13.51 = 9.58 mbars
(6) RH	13.51 ÷ 23.09 = .585 (x100 = 58.5%RH)
(7) Specific Vol.	0.84 m ³ /kg dry air
(8) Enthalpy	42.10 kj/kg dry air
(9) Enthalpy correction	<u>-.12</u>
True Enthalpy	41.98 kj/kg dry air

Properties vary with altitude because partial pressure of air decreases as altitude above sea level increases, while that of the water vapor remains constant. As a result, a kilogram of dry air at high altitudes has a higher water content than a kilogram of dry air at lower altitudes. This results in higher humidities, higher heat content and large volume per kilogram dry air.

Attached in Appendix A3 are psychrometric charts for sea level, 750, 1,500, 2,250 and 3,000

meters. Use of these at intermediate altitudes result in error of plus or minus 5%.

Many charts are in non-SI units. A table for conversion to SI units is provided in Appendix A1.

Calculation of Cooling Requirements

Failure to provide sufficient cooling carries heavy penalties. Usually as a result of heat gain through the storage structure, thermal runaway conditions can develop, which may produce substantial deterioration in the final months of storage. This is particularly serious where capital and operating costs for equipment have been borne to that date. On the other hand, an oversized cooling plant is uneconomical due to the high capital cost of refrigeration equipment in relation to the value of the crop.

The maximum cooling load is made up of the following components:

- (1) cooling load from field heat to storage temperature including high initial respiration,
- (2) heat produced by respiration during storage,
- (3) heat gain through structure,
- (4) heat gain by air leakage, and,
- (5) heat from fans and other equipment.

(1) Cooling Load

Field heat of potatoes plus the high respiration rates at harvest time commonly account for 50 percent to 70 percent of total cooling requirements.

Climatic conditions in some countries may permit use of ambient forced draft air at night for this initial part of the cooling requirements, while in other countries, where potatoes are grown in the cool season and stored through the hot season, refrigeration will be required. It is recommended that potatoes be cooled at 1° to 2°C per day until reaching curing temperatures of 15° to 17°C. After a curing period of 1 to 2 weeks additional gradual cooling at 0.5° to 1°C per day is recommended. When temperature reduction by forced draft ambient air is impossible, refrigeration equipment can be used, and its size can be calculated accordingly.

Field temperature of potatoes is about the same as air temperature. During severe high temperature conditions harvesting during the cool part of the night should be considered. Harvested tubers should not be left exposed to the sun.

The amount of cooling required to remove field heat is the sum of two heat sources: specific heat from reduction in temperature plus heat of tuber respiration.

Specific heat for potatoes is 3430 kJ per TM per degree Centigrade.

Respiration heat is highest at the high harvest temperatures and during curing. Although the respiration heat lessens with decreasing temperature the design of a cooling system must be adequate for the maximum cooling needs.

(2) Respiration Rate/Heat (kJ/TM/hr)

Curing tubers	200
Sprouting tubers	104
Mature tubers at 0°C	85-100
5	40
10	65
15	85
20	110
25	180

Immature tubers 2 to 3 times the above.

Note that respiration heat drops with decreasing temperature, thus, the maximum cooling requirement lasts for only a few days. It is cheaper to use forced draft ambient night air for this initial requirement if outside temperature permits, rather than to install excess refrigeration capacity for these few days.

(3) Heat Gain Through Structure

Heat gain is the largest component of the cooling load after allowing for initial field heat and respiration. The effect of direct solar radiation can be very great with roof temperatures of 90°C and wall temperatures as much as 15°C higher than ambient. Store design should treat the roof as an *umbrella* by placing it independent of the storage room with an open space for free movement of ambient air between roof and storage room. Extend the roof to shade the walls. Where this is impossible paint the exposed walls a reflective white.

With such a design the store is a separate room in the shade. There is no effect of direct solar radiation and design calculations for insulation can be based on ambient air temperatures.

The insulation of the building should have a maximum (*U*) value of

$$\frac{5.8 \text{ kJ}}{\text{hr} \times \text{m}^2 \times ^\circ\text{C}}$$

in most tropical locations and preferably as low as

$$\frac{2.0 \text{ kJ}}{\text{hr} \times \text{m}^2 \times ^\circ\text{C}}$$

(4) Heat Gain by Leakage

A well constructed building has very little leakage of cool air that is replaced by warmer ambient air. The following listing may be used as a guide. This is important only in mechanically refrigerated stores. In natural convection or forced draft ventilated stores this air change is part of the ventilation air.

Volume of building (m ³)	Air change/hour (leakage)
28	0.43
142	0.18
283	0.12
566	0.09
1,133	0.06
2,832	0.03

(5) Heat Gain from Equipment

The table shows typical values for electric motors. Note that gain is reduced by 40% when electric motors are outside refrigerated space.

Heat Equivalent of Electric Motors

Motor horse power	Megajoule/HP/h	
	Connected load in refrigerated space (i)	Motor losses outside refrigerated space (ii)
1/8 to 1/2	4.48	2.68
1/2 to 3	3.90	2.68
3 to 20	3.11	2.68

i-Use when both useful output and motor losses are dissipated within refrigerated space such as motors driving circulation fans and similar equipment.

ii-Use when motor losses are dissipated outside refrigerated space and useful work of motor is expended within refrigerated space, for example, a pump on a circulating chilled water system, fan motor outside refrigerated space driving fan circulating air within refrigerated space.

Based on the information, total cooling requirements can be calculated.

Example 1:

Harvest 100 TM of potatoes at 25°C.

Place in store (10 m x 10 m x 3 m) insulated to a (U) value of

$$\frac{2.2 \text{ kJ}}{\text{m}^2 \times \text{hr} \times ^\circ\text{C}}$$

- Cool potatoes from 25°C to 15°C at 1°C per day.
- Hold potatoes at 15°C for curing.
- Cool potatoes from 15°C to holding temperature of 10°C.
- Hold potatoes at 10°C.

Calculated major cooling requirements in periods A to D described above.

Period A

- Cooling load = $100 \text{ TM} \times \frac{3430 \text{ kJ}}{\text{TM} \times ^\circ\text{C}} \times \frac{0.04 ^\circ\text{C}}{\text{hr}}$
= 13,720 kJ/hr
 - Respiration = $100 \text{ TM} \times \frac{200 \text{ kJ}}{\text{TM} \times \text{hr}} = 20,000 \text{ kJ/hr}$
 - Heat gain = $220 \text{ m}^2 \times \frac{2.2 \text{ kJ}}{\text{m}^2 \times \text{hr} \times ^\circ\text{C}} \times (25 - 15^\circ\text{C})$
= 4,840 kJ/hr
- Total Requirement = 38,560 kJ/hr

Period B

- Respiration = $100 \text{ TM} \times \frac{200 \text{ kJ}}{\text{TM} \times \text{hr}} = 20,000 \text{ kJ/hr}$
 - Heat gain = $220 \text{ m}^2 \times \frac{2.2 \text{ kJ}}{\text{m}^2 \times \text{hr} \times ^\circ\text{C}} \times 10^\circ\text{C}$
= 4,840 kJ/hr
- Total Requirement = 24,840 kJ/hr

Period C

- Cooling load = $100 \text{ TM} \times \frac{3430 \text{ kJ}}{\text{TM} \times ^\circ\text{C}} \times \frac{0.04 ^\circ\text{C}}{\text{hr}}$
= 13,720 kJ/hr
 - Respiration = $100 \text{ TM} \times \frac{85 \text{ kJ}}{\text{TM} \times \text{hr}} = 8,500 \text{ kJ/hr}$
 - Heat gain = $220 \text{ m}^2 \times \frac{2.2 \text{ kJ}}{\text{m}^2 \times \text{hr} \times ^\circ\text{C}} \times (25 - 10^\circ\text{C})$
= 7,260 kJ/hr
- Total Requirement = 29,480 kJ/hr

Period D

- Respiration = $100 \text{ TM} \times \frac{65 \text{ kJ}}{\text{TM} \times \text{hr}} = 6,500 \text{ kJ/hr}$
 - Heat gain = $200 \text{ m}^2 \times \frac{2.2 \text{ kJ}}{\text{m}^2 \times \text{hr} \times ^\circ\text{C}} \times 15$
= 7,260 kJ/hr
- Total Requirements = 13,760 kJ/hr

Note that the cooling load is 38,560 kJ/hr during the first phase of storage but only 13,760 kJ/hr after the potatoes reach the final holding conditions.

Based on calculations using the procedures given above we now know how much cooling is needed for our store. The decision must then be made on (1) how this cooling will be supplied, (2) how much ventilating air is required, and, (3) how to distribute the ventilating air.

Cooling supply

The choice of cooling supply requires a knowledge of the external and internal climates and an understanding of psychrometrics and additionally the technical, cost, and social benefits of the use of artificially cooled air. The selected method frequently involves a compromise between technical, economic, and social factors. As stated above failure to provide sufficient cooling carries heavy penalties while oversized cooling plants are uneconomical.

Some of the technical factors associated with different ventilating systems appropriate to potato stores are discussed below.

In addition we should observe that if in the above example a refrigeration system was installed to remove the maximum heat load of 38,560 kJ/hr it would only be used to approximately 50 percent capacity during the major holding period with a heat load of 13,760 kJ/hr.

Thus, wherever climatic conditions are favorable, cool night ambient air should be used to reduce the need for artificial cooling plants.

Calculation of Ventilation Requirements

Knowing how much cooling is required and how this will be supplied we must calculate how much ventilating air of specific properties, whether ambient or artificially cooled air, is required. This can be done by using psychrometrics.

Example 1: continuing from the above example

Maximum cooling requirements	=	38,560 kJ/hr
Capacity of installed refrigeration plant	=	2-ton refrigeration
(1 ton refrigeration)	=	12,658 kJ/hr
	=	25,316 kJ/hr
Deficit cooling requirements	=	13,244 kJ/hr
Ambient night air available	=	12 hours at 17°C DB and 12.5°C WB
Air leaving the store	=	20°C DB and 15°C WB

Calculate how much ambient air is required during 12 hours ventilation to supplement the 2-ton refrigeration unit.

From psychrometric charts at sea level

	DB	WB	% RH	kJ/kg dry air	m ³ /kg dry air
Air entering store	17.0	12.5	60	36.0	0.83
Air leaving store	20.0	15.0	60	42.1	0.84

Heat gain by ambient ventilating air

$$= 42.1 - 36.0 = 6.1 \text{ kJ/kg dry air}$$

Amount of ventilating air needed to remove 13,244 kJ/hr

$$= \frac{13244 \text{ kJ}}{\text{hr}} \times \frac{\text{kg dry air}}{6.1}$$

$$= 2171 \frac{\text{kg dry air}}{\text{hr}}$$

$$\text{volume of air needed} = 2171 \frac{\text{kg dry air}}{\text{hr}} \times \frac{0.84 \text{ m}^3}{\text{kg dry air}}$$

$$= 1824 \text{ m}^3/\text{hr}$$

This quality of air is only available for 12 hrs and as the requirements are for 24 hrs the volume of air per 12 hrs ventilating period must be doubled:

$$1,824 \times 2 = 3,648 \text{ m}^3/\text{hr}$$

This results in an air flow of 36.48 m³/TM/hr during the 12 hrs to supplement the refrigeration plant.

Similar calculations can be carried out to determine air flow needs when all the cooling is provided by either ambient or artificially cooled air.

Normally recommended forced draft air flow rates fall within the range 67 to 86 m³/TH/hr, with a suggested minimum of 35 and a suggested maximum of 135 m³/TM/hr.

Ventilation System

Ventilation is required to maintain the temperature of stored potatoes at the selected level. In this context ventilation implies introduction of cooler air to remove heat. Initially, field heat must be removed from a crop just placed in storage. Once the temperature in a store is reduced to a given level, ventilation is required to maintain that level due to heat inputs from potato respiration and heat gain from solar radiation through the materials of the building walls or roof as calculated above.

Ventilation systems may be divided into those using ambient air and those using artificially cooled air.

Ambient Air Ventilation

Ambient (or outside) air temperatures vary in different potato growing areas. Usually day temperatures are high and night temperatures are low. A basic rule for using this cool night air is that ambient temperatures must be below the desired store holding temperature at least for 30 percent to 40 percent of the time if that temperature is to be maintained by ambient air ventilation alone. Ambient air ventilation may be subdivided into systems relying upon Natural Convective Ventilation (NCV) and those using Forced Draft Ventilation (FDV).

Natural convective ventilation (NCV). Metabolic heat raises the temperature of both the potatoes and the air between them, resulting in development of convective currents within the stack. Warmed air rises out of the stack at a rate depending upon the difference between its density and that of the cooler ambient air that flows in to replace the heated air. This creates a natural convective transfer of heat from the stack. In a closed system a state of thermodynamic equilibrium is reached which in most situations is at a higher mean stack temperature than the optimum. Exposure to cooler night ambient temperatures can help increase natural convection ventilation and thus reduce stack temperature. Thus stores should be designed so that the ventilating system can easily be opened at night or whenever ambient outside temperatures are 3° to 5°C below the stack temperature and closed during the day when ambient temperatures are above the stack temperature. Complete false floors or large open-ended ducts

Figure 38. Stack height and stack temperatures.

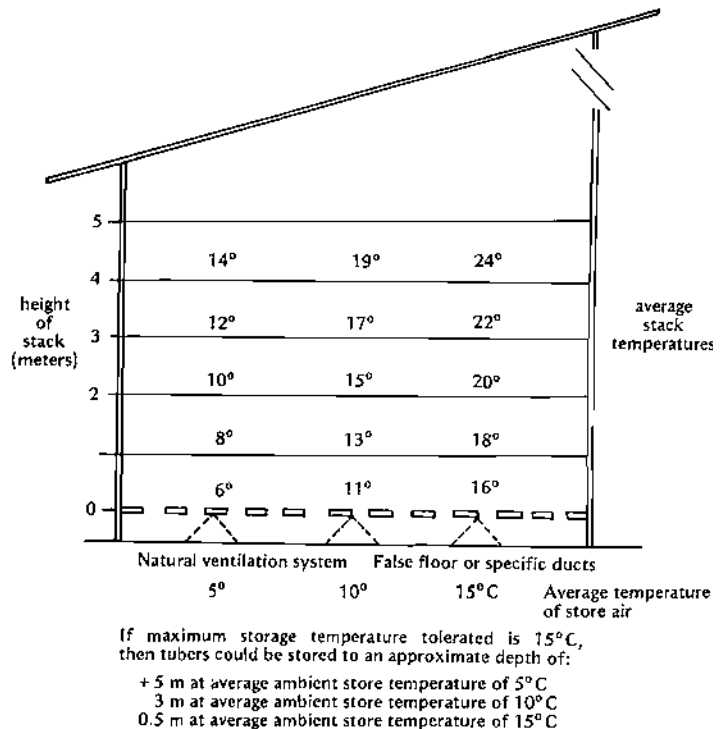

under the stack and sufficient air space above the stack aids in the circulation of this cooler air.

Convection ventilation creates a difference in temperature between the top and bottom of the pile of tubers which is about 2°C for every meter of storage depth. This factor together with the availability and temperature of ventilating air will determine the maximum height to which potatoes may be stored under ambient conditions (Figure 38). The temperature differential range within a pile may be lessened by reducing the height of the pile or by using forced draft ventilation.

When the warm, humid air rising to the top of a stack is cooled sufficiently by the influence of the surrounding ambient air some of the moisture the air contains may condense. If this condensation is on the cooler top layers of potatoes conditions become ideal for development and spread of bacterial soft rots. To avoid this, cover the stack immediately after loading into the store with about a half meter of loose straw into which this moisture will condense.

Forced Draft Ventilation (FDV) makes greater use of ambient cool air, especially if the cool air is available for limited periods to obtain near or optimum storage temperatures and to reduce the pile temperature differential. Forced draft ventilation value must always be judged in terms of overall cost benefits, availability of power and management expertise. In estimating the amount of ventilation required in a potato store consider:

- total and specific cooling requirement,
- average outside air temperature and range of temperatures,
- duration that outside air temperature is below desired store temperature,
- type of air distribution system.

Forced draft ventilation may be either continuous or discontinuous in nature. Continuous ventilation systems are characterized by lower ventilation rates than discontinuous systems. The type of system selected will depend largely on the quality of the ventilation air available and on the ventilation rate required to obtain and maintain the selected internal store environment. The ventilation rate required will, of course, be influenced by the number of hours which air of suitable qualities for use in ventilation is available. For example, with suitable outside ambient air available for only 4 hours a day, six times the ventilation rate is required than when suitable refrigerated air is available for 24 hours a day and even then will give less exact control over the store temperature and stack differential.

During convection ventilation, water loss from tubers is restricted by the water-holding capacity of a limited amount of slowly moving air. This is exchanged for tuber water loss tending toward the ultimate limit set by the permeability of the potato periderm to water vapor by using high rates of forced draft ventilation. Thus, under conditions where most cooling is by evaporation of water from the tubers, there is no reason to increase ventilation rates above the point where the peri-

derm becomes the controlling factor. Under conditions in which considerable cooling is by radiation it is better to have a given degree of temperature control by rapid ventilation for a short time. Water loss limits set by the permeability of the periderm are approximately 0.5 percent tuber weight per week per mbar VPD in freshly harvested tubers and 0.15 percent per week per mbar VPD in well cured mature tubers. This limit to water loss will again rise considerably in sprouted tubers due to the much greater permeability of sprout surfaces.

Ventilation with Artificially Cooled Air

Two systems of artificially cooling ambient air are available for potato stores. These are evaporative cooling and refrigeration. Both systems are most effectively used in conjunction with a forced draft air distribution system and a recirculation system will considerably reduce costs of the refrigeration load.

(1) **Evaporative cooling.** Evaporative cooling has the following advantages:

- temperature of air is reduced,
- humidity of the air is increased.

The combined effect is to reduce the VPD.

Evaporative cooling is particularly effective when the wet bulb temperature is more than 4°C below the dry bulb temperature. The larger the wet bulb depression, the greater the advantages of evaporative cooling. Referring to the psychrometric chart (sea level), the cooling of the air follows the wet bulb temperature line.

Example:	DB	WB	DP	% RH	Vapor Pressure	VPD	
fresh air	20	15	12	59	23.1(20°)	13.9 (12°)	9.2
cooled air	17	15	13.8	81	19.2(17°)	15.6 (13.8°)	3.6

We have reduced the VPD by 5.6 mbars and increased RH percent by 22.

It is difficult to increase RH percent above 80 percent RH by evaporative cooling alone.

(2) **Refrigeration** is commonly used to remove heat from a storage space. Refrigeration systems consist of four main components functioning in a closed cycle. These components--the compressor, the condenser, the expansion valve and the evaporator--and their functions are described in Appendix A4. Refrigeration requirements can readily be determined from the total cooling requirements.

To save money and prevent the exhaust of refrigerated air after it has passed through the stored tubers, a recirculation system should always be linked to the air distribution system where refrigeration is used. The forced draft system of distributing the refrigerated air through the tubers is recommended for potato stores. Such a system gives the greatest efficiency and flexibility allowing tubers to be stored in either bulk or containers. Refrigerated air sometimes is introduced into the stores just below the ceiling and is then allowed to fall by gravity around the stored crop. For suc-

cessful cooling and use of this system the stored crop must be carefully stacked in open containers. This system is not recommended for purpose-built potato stores and it cannot be used for any bulk potato stores.

As with all potato stores, the construction of refrigerated potato stores must comply with the described requirements of weather protection, tuber retention, and insulation. This need not necessarily mean that refrigerated stores are more expensive than non-refrigerated stores. Provided the above requirements are met, the cheapest locally available materials can be used.

Humidification Systems

Attempts to reduce evaporative losses from tubers must be directed at reducing the VPD of the ventilating air. When available ventilating air is of low relative humidity this may be done by artificial humidification systems or with the previously mentioned evaporative cooling, if appropriate.

In providing artificial humidification for stores using forced draft ventilation finely atomized water particles are introduced into the ventilating air downstream from the fan. To be most effective and to avoid carrying free water into the store, the water supply must be pressurized, necessitating the use of a pump. An alternative to atomized water is injection of steam into the ventilating air. A further alternative is to fit the main duct with humidifying barriers such as charcoal or jute sacking through which water is continuously cycled.

In simpler storages relying on natural convective ventilation, other simpler humidification systems must be used. Water can be periodically introduced beneath the false slatted floors in stores of that type. Sometimes irrigation canals or small streams can be diverted to run below the false floors of stores. It may be beneficial to agitate the water to obtain greater surface area for humidification.

Within all store types it is easier to obtain and maintain high relative humidity of the inside air when the store is filled to capacity. A full small store is better than a half full large store. Natural earth floors greatly aid in maintaining high humidity if they are well moistened prior to filling the store.

Air Distribution

Whatever ventilation system is used within the building, introduced or recirculated air must flow as evenly as possible through the stored crop. Distribution is a function of resistance to airflow by the potatoes, size of duct, placement of ducts, and location and size of inlet and exhaust openings. In ventilation and air distribution, air always takes the path of least resistance.

Resistance to Airflow

Where any type of forced draft ventilation is to be used, employ the following basic information to properly select a fan: (1) quantity of air to be moved in a given time (m^3/hr) and (2) pressure against which the fan is to operate (for instance,

millimeters static water gauge (s. w. g.) or total water gauge (t. w. g.)).

A potato store has two major components of air resistance. One consists of the ductwork (and additionally in the case of refrigerated stores the evaporator coils) and the second is the combined resistance of the potatoes and the exhaust vents. Such resistances require pressure to overcome them. This pressure, in turn, has three aspects: (1) *velocity pressure* (P_v), produced by speed of air movement; (2) *static pressure* (s. w. g.), which maintains flow against resistance; and (3) *total pressure* (t. w. g.), the sum of the velocity and static pressures.

In a potato store, usually only the static water gauge is measured. For clean, unsprouted potatoes this will not exceed 0.75 mm s. w. g. per meter of height of the stack. If considerable soil is included with the stored potatoes this will rise to about 1.85 mm s. w. g. per meter. In cases where considerable sprouting has occurred s. w. g. may rise to 7.5 mm per meter.

Resistance due to ductwork is fixed by the size and layout of ducts. In the case of a single straight main duct with laterals at right angles it is unlikely to exceed 12.5 mm s. w. g. Thus, the total static water gauge for a stack of potatoes 3.5 m high could vary from 15 mm to 43 mm s. w. g.

Consider that a well-designed bulk store installation consists of a main air duct and laterals and that it contains potatoes loaded to a height of 4 m with soil extraction equipment on the input elevator plus swinging head extension to prevent soil cones. Recommended for this structure would be rated fan air flow of $67 m^3/TM/h$ and 25 mm s. w. g. For a lesser installation without soil extraction equipment but otherwise as above, the static pressure rating of the fan should be increased to 38 mm s. w. g. and to 50 mm s. w. g. for installations with design limitations such as numerous bends in air duct and likely presence of soil cones.

When storing in bags instead of in bulk, the stacking method should promote maximum even air flow through the tubers and not simply around the stacks. Open net bags offer less resistance to air flow than thick jute or burlap bags.

Size and Distribution of Ducts

In small naturally ventilated stores a complete false slatted floor is desirable. In most other circumstances ductwork is required and usually includes a main duct supplying a number of lateral ducts. The main duct function is to provide a single attachment point for the fan and to feed lateral ducts that distribute air under the stored crop. Several small fans, one attached to each lateral duct, for example, are never as economical as a single large fan of suitable capacity. Include flap valves on laterals for control of air distribution to individual parts of the store.

Design and Distribution. Both main and lateral ducts may be either above or below ground level. However, main ducts above ground are

usually cheaper to construct and may be built into the load bearing walls or form part of a physical store division. Main ducts are usually rectangular in cross section. The circular discharge orifice of axial fans must be blended into the duct with a transformation piece. Centrifugal fans commonly have a rectangular orifice.

With any fan type avoid discharging air into a larger or smaller duct without gradual transformation. Sunken laterals offer no advantages in terms of air distribution but they may be more convenient in large bulk or box stores. Below-ground ducts are usually rectangular and are covered with boards 100 to 150 mm wide with gaps up to 25 mm between each board (Figure 39). Above-ground laterals are usually triangular and constructed of slatted timber strips with gaps between strips of not more than 25 mm. Alternatively, tubular ducts with holes may be used (Figure 39).

All ducts must be straight and unobstructed. If bends are unavoidable make them gradual and rounded. Guide vanes must be installed inside the airduct, an important point especially if the air discharge is at right angles to the main duct. The interior of ducts must be smooth for minimum resistance to air flow. Avoid obstructions in the immediate vicinity of lateral duct take off points.

The position of the main duct is related to the individual store configuration. Three arrangements are illustrated in Figure 40. Spacing of lateral ducts for final distribution of air is a compromise between cost and performance. Experience indicates a maximum spacing of 2 m between laterals (based on center to center measurement). Air flow and problems inherent in wider spacing are illustrated in Figure 41. Maximum recommended length of lateral ducts is normally 12 to 14 m. If longer ducts are essential then some revision of the recommended minimal cross sectional area (1,300 mm²/TM of potatoes ventilated) must be made. Very long ducts should be "stepped" for the most economical arrangement (Figure 42).

Size. Calculation of duct size is by the velocity method in which air velocity in various sections is selected. Reduce air velocity progressively through the system from a maximum in the main duct to a minimum at discharge from the building through exhaust openings. Main duct air velocities should be 10 to 13 m/s, below 10 m/s in lateral ducts and no more than 4 m/s in exhaust openings.

In a convective air flow system frictional losses must be negligible by ensuring duct air speed does not exceed 3 m/s. Thus, if convective air flows are at a maximum of 13.5 m³/TM/hr all ducts must have a minimum cross sectional area of 1,300 mm² per TM of potatoes ventilated.

Air velocity decreases towards the closed ends of ducts as there is a region of static pressure. The problems of uneven distribution associated with this can be counteracted in both main and lateral ducts by tapering the duct and/or providing sufficient cross sectional area to keep initial velocities low. In lateral ducts this problem may also be re-

medied by reducing the distance between boards along the lateral so that at the far end the gaps are one-third the size of those at the point of connection with the main duct.

For example, potatoes are 3 m deep in a store with a system of lateral duct spacing centered at

Figure 39. Lateral duct design. A -- Above ground. Slatted triangular duct (may also be square or rectangular or a round tube with numerous air holes). B -- Below ground. Sunken concrete duct. (From *Control of Environment, Part 2, Potato Marketing Board, Sutton Bridge Experimental Station, Report No. 6, London*).

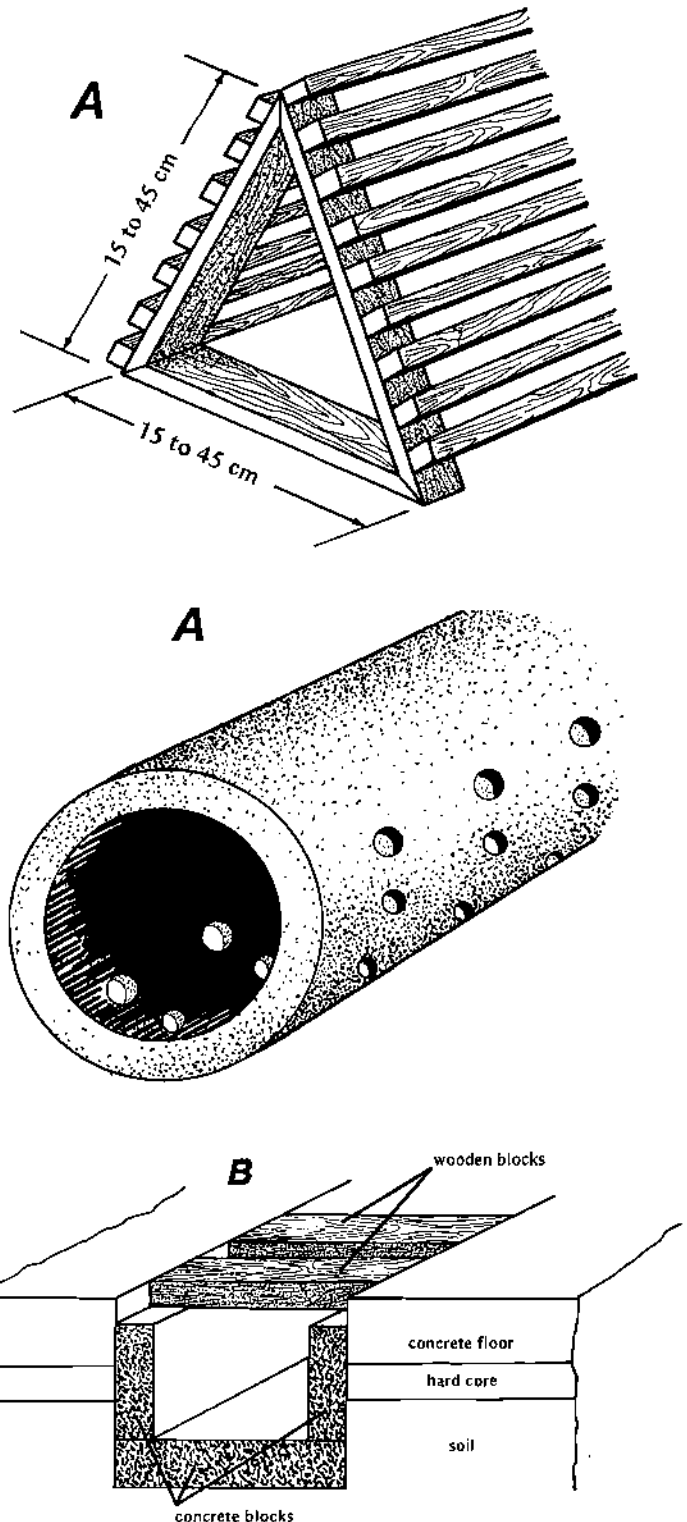
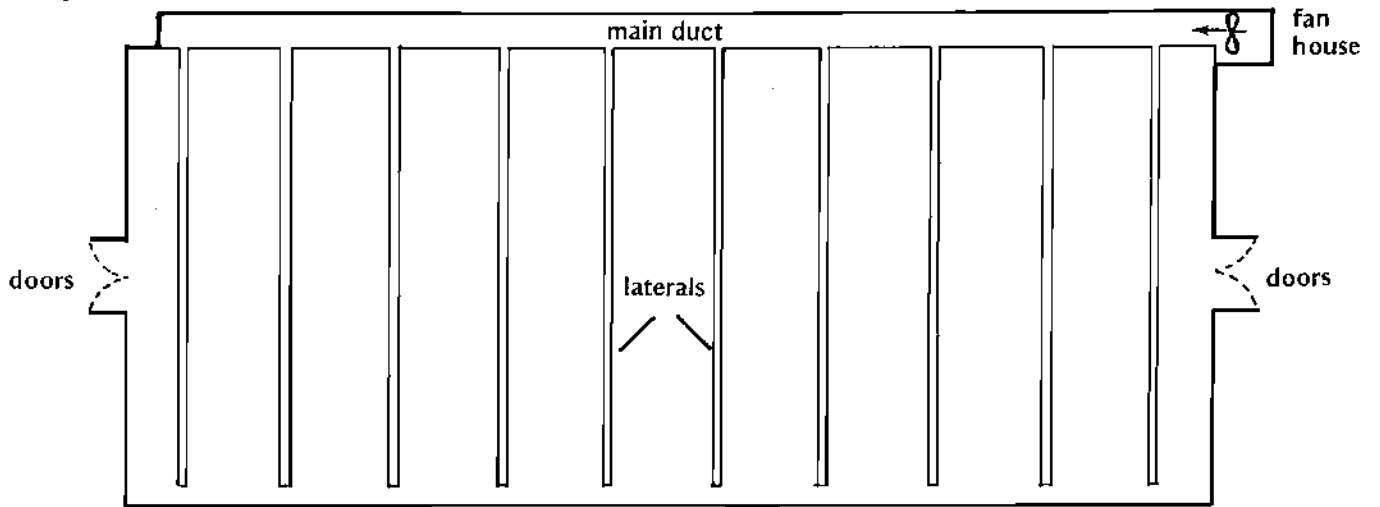
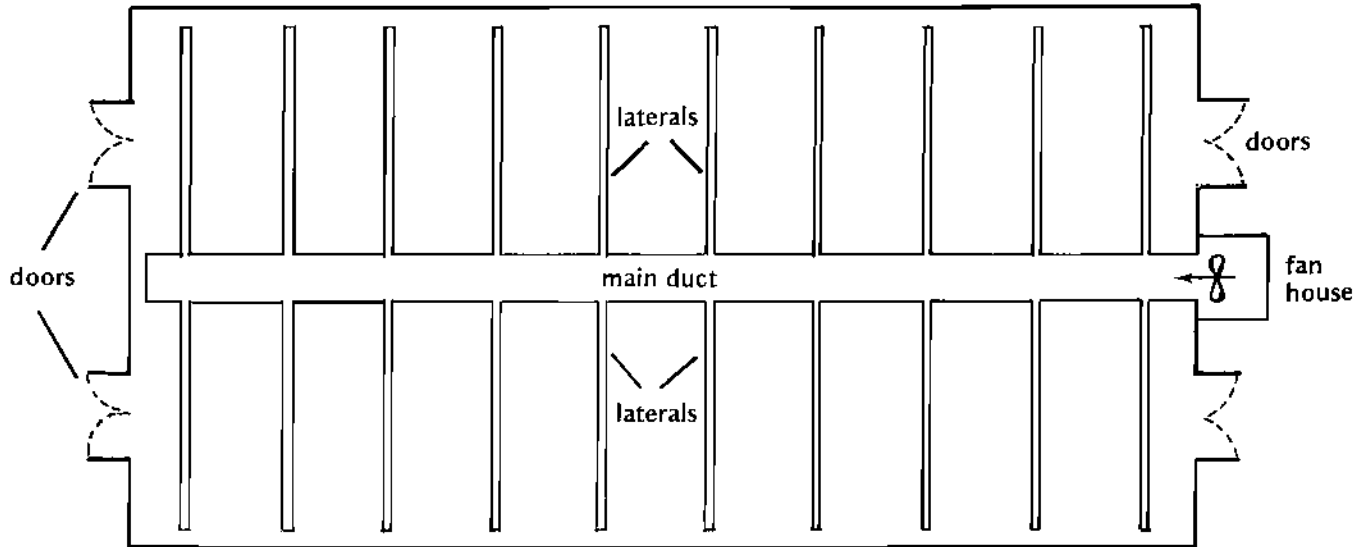

Figure 40. Air duct distribution. (From *Control of Environment, Part 2, Potato Marketing Board, Sutton Bridge Experimental Station, Report No. 6, London*).

A – Longitudinal Main Duct



B – Central Main Duct



C – Lateral Main Duct

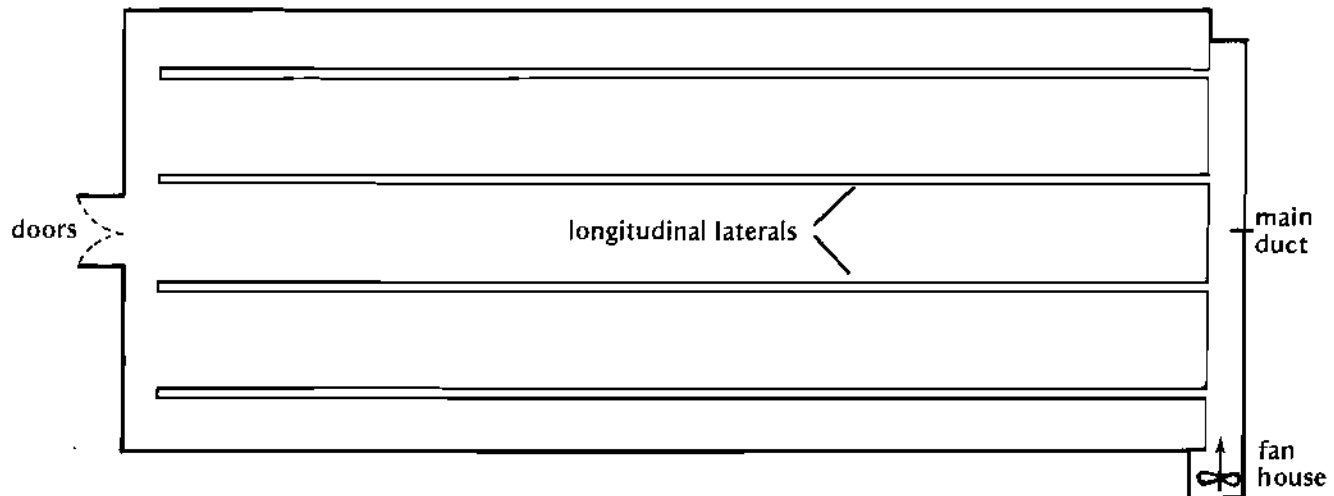

A – Correct Spacing

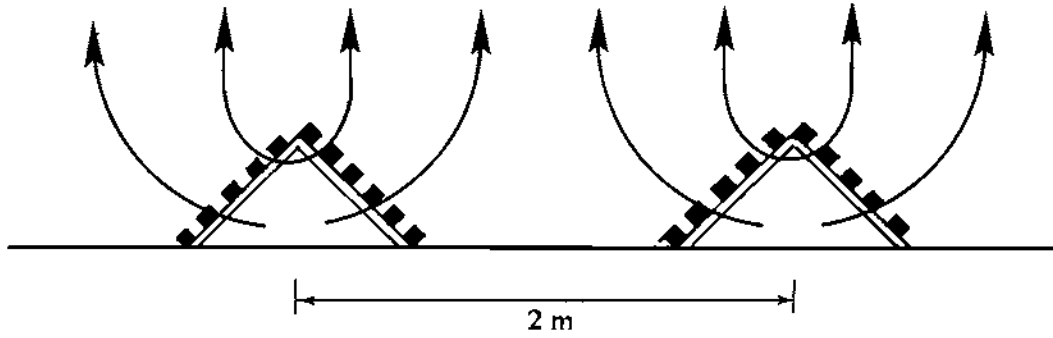

B – Spacing Too wide

poorly ventilated
cone of tubers

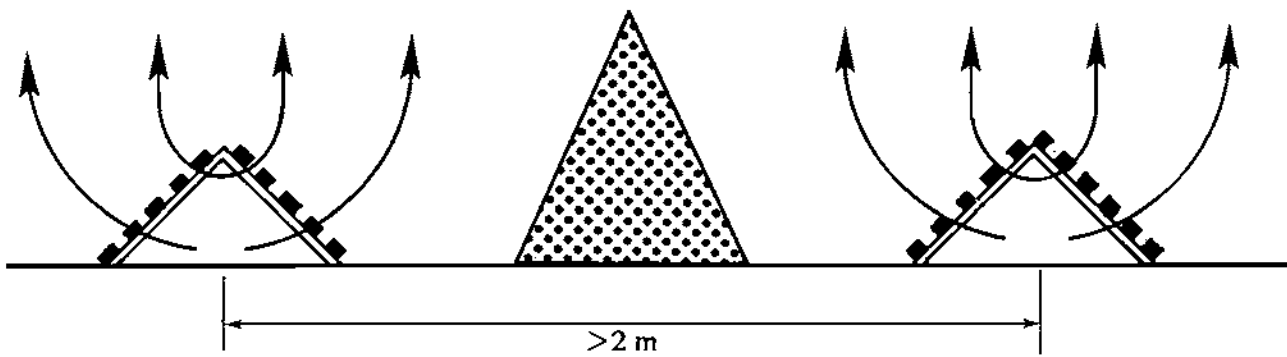
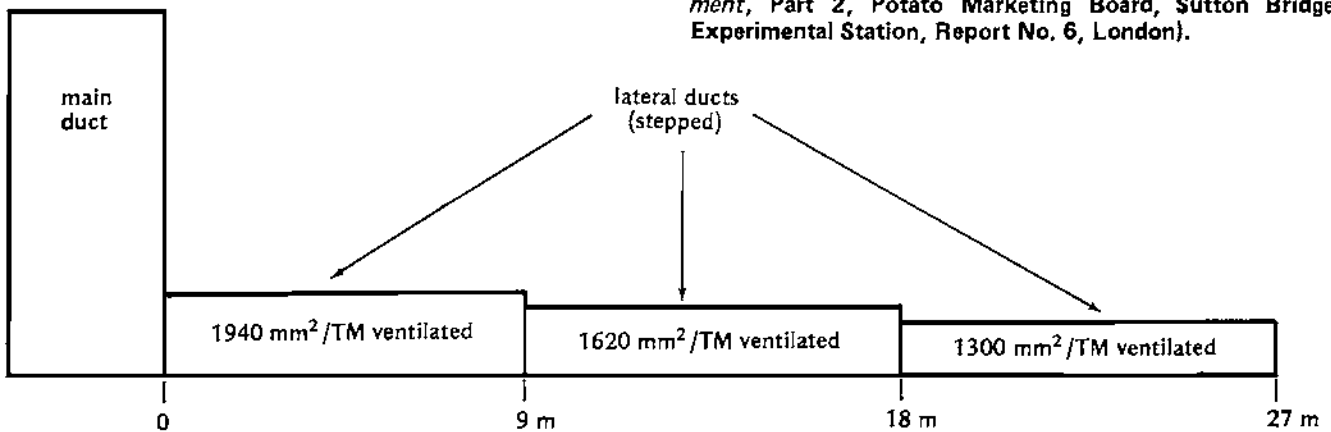

Figure 41. Lateral duct spacing. A – Correct spacing. B – Spacing too wide. (From *Control of Environment, Part 2, Potato Marketing Board, Sutton Bridge Experimental Station, Report No. 6, London*).

Figure 42. Lateral duct size. (From *Control of Environment, Part 2, Potato Marketing Board, Sutton Bridge Experimental Station, Report No. 6, London*).



2 m, each duct being 9 m long and FDV ventilation to maintain the desired internal temperature is at the rate of 67 m³/TM/hr.

Thus, the tonnage of tubers ventilated by each lateral duct will be:

$$3 \text{ m} \times 2 \text{ m} \times 9 \text{ m} \times \frac{0.6 \text{ TM}}{\text{m}^3} = 34 \text{ TM}$$

Therefore, the total air flow in each lateral will be:

$$\frac{34 \text{ TM} \times 67 \text{ m}^3}{\text{TM} \times \text{hr}} = 2,278 \text{ m}^3/\text{hr}$$

If the maximum recommended air flow in the duct is 10 m/s the cross section area of the ducts will need to be:

$$\frac{2,278 \text{ m}^3}{\text{hr}} \times \frac{\text{sec}}{10 \text{ m}} \times \frac{\text{hr}}{3,600 \text{ sec}} = 0.063 \text{ m}^2$$

or alternatively

$$\frac{0.0633 \text{ m}^2}{34 \text{ TM}} = 0.0019 \text{ m}^2/\text{TM ventilated}$$

Thus, the lateral ducts could for example be 0.252 m x 0.252 m below ground square ducts.

Assuming that we did not want the average air velocity at the point of entry into the potato stack to exceed 4 m/s the total free area comprising the gaps between cover boards of the laterals would be:

$$2,278 \frac{\text{m}^3}{\text{hr}} \times \frac{\text{sec}}{4 \text{ m}} \times \frac{\text{hr}}{3,600 \text{ sec}} = 0.158 \text{ m}^2$$

Given that the ducts are 0.252 m wide this would require a total length of gaps of

$$\frac{0.158 \text{ m}^2}{0.252 \text{ m}} = 0.627 \text{ m}$$

This could be obtained by 50 gaps each of 12.5 mm.

However, in practice the air will not leave the duct at a uniform rate of 4 m/s but may range from 2.3 m/s nearest the main duct to 6.8 m/s at the closed end of the duct which will result in uneven air distribution as calculated below.

Air leaving far closed end of duct will be

$$0.252 \times 0.0125 \times 6.8 \times 3,600 = 77.11 \text{ m}^3/\text{hr}.$$

This may be remedied as explained above by keeping the total area of gaps the same (0.158 m²) but by altering the spacing as follows:

- first 3 m spacing of 19 mm
- middle 3 m spacing of 12.5 mm
- last 3 m spacing of 6.35 mm

Thus, resulting in an even air flow as calculated below

$$\text{Far end: } .252 \times .0064 \times 6.8 \times 3600 = \frac{40 \text{ m}^3}{\text{hr}}$$

$$\text{Near end: } .252 \times .019 \times 2.3 \times 3600 = \frac{40 \text{ m}^3}{\text{hr}}$$

All lateral ducts should end 0.3 to 0.45 m from the store wall to avoid excess air loss up the smooth face of the wall. Similarly, level filling of bulk stores is essential to guarantee even distribution of air (Figure 43).

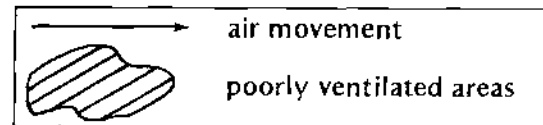
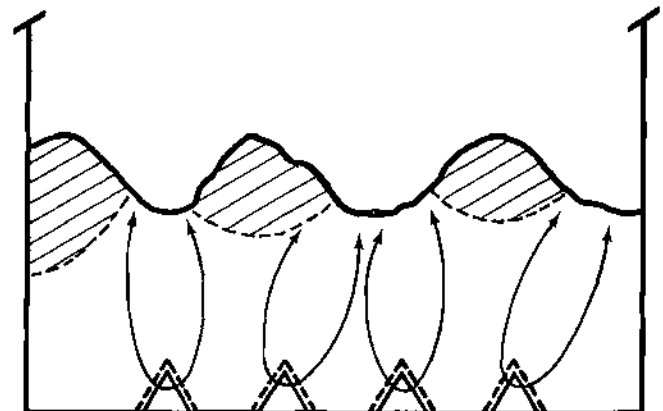
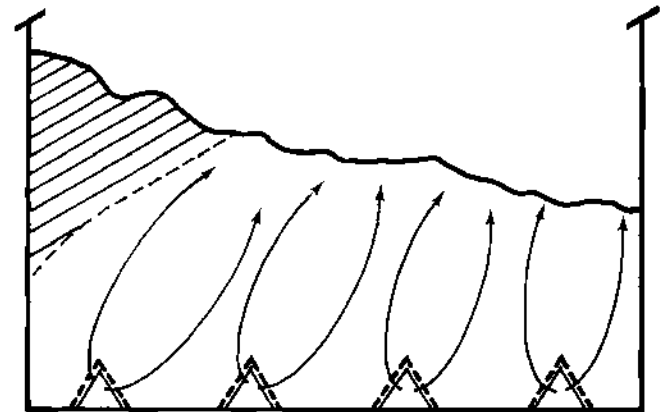
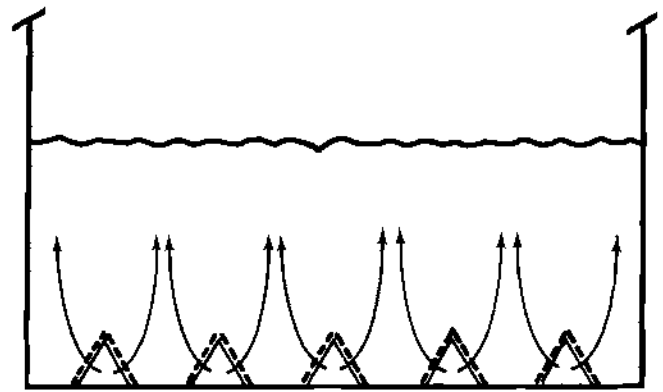
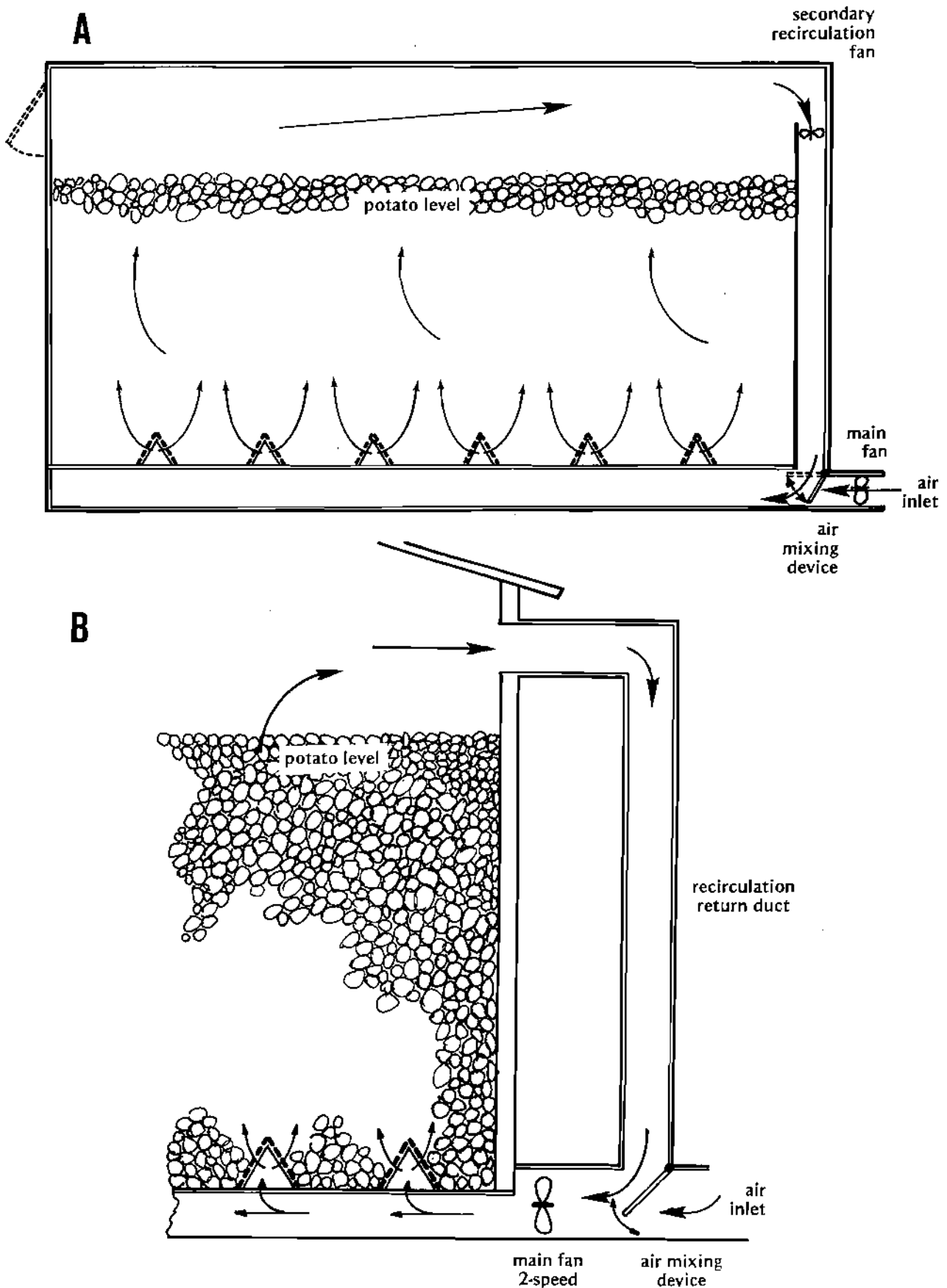

Figure 43. Importance of level filling in a bulk forced draft store.

Recirculation

Recirculation of air within a potato store is an important management aid when ventilating with artificially cooled air. To introduce ambient air at a high temperature, then to cool it before it passes through the stored tubers only to exhaust it several degrees higher is extremely wasteful. Also recirculation of store air can be used to reduce the temperature gradient within the pile of stored tubers. Most recirculation systems also allow for mixing of ambient and artificially cooled ventilating air.

Figure 44. Recirculation systems. A -- Secondary recirculation fan. B -- Main fan with return duct. (From *Control of Environment, Part 2*, Potato Marketing Board, Sutton Bridge Experimental Station, Report No. 6, London).



Three mechanical systems are used for recirculation:

- (1) Recirculation fan and chimney independent of main ventilating fan (Figure 44A).
- (2) Two-speed main fan with recirculation duct (Figure 44B).
- (3) Main fan used intermittently.

Recirculation air flow rates in excess of $35 \text{ m}^3 / \text{TM/hr}$ are not recommended unless the system using intermittent use of the larger main fan is selected.

Inlet and Exhaust Openings

Air inlets must be carefully designed and located in systems relying on introduction of cool ambient air. Position them to take maximum advantage of natural prevailing air currents. Make them large enough and have enough of them to permit introduction of large volumes of cool air, especially when the air is available only during restricted periods (for instance, at night). It is virtually impossible to provide too many ventilators as the degree of air flow can be controlled by appropriate management. Design inlets for easy opening or closing. Protective devices are a must to prevent entry of rodents and, especially in the case of seed, to restrict entry by insects such as aphids and tuber moth.

Where only natural convection ventilation is used, external inlets can open onto an open false floor ventilating system, numerous individual main ducts, or a fewer number of main ducts each with several lateral ducts depending on the size and particular design and location of the store.

In forced draft ventilation systems one main duct provides a single attachment point for the fan with the required number of laterals gradually reducing air velocities along the system as described above.

In simple natural convection ventilated stores, the air can be exhausted from an open ridge or similar alternative arrangement. In such a system a minimum of 0.55 m^2 of exhaust opening should be provided for every 100 TM of potatoes in store.

In forced draft stores open ridge exhaust arrangements are not practical so controllable end or side ventilators are often used. The total free cross sectional area of these exhaust ventilators should be not less than 0.068 m^2 per $1,000 \text{ m}^3/\text{hr}$ of fan capacity. The simplest form of controlled exhaust ventilators for use with forced draft ventilation are counterbalanced flap valves actuated by the increased internal pressure created when the fan is in operation (Figure 45).

All exhaust vents must be above the level to which potatoes are loaded and as near to the apex of the building as possible. This increases the "chimney effect" and aids extraction particularly with convective ventilation. If loose straw or similar material is not used on top of the stored crop, ventilator arrangements must be light proof in the case of consumer potatoes to prevent greening. This can be done with hoods and baffles (Figure 46). Free air space between the top of the potato

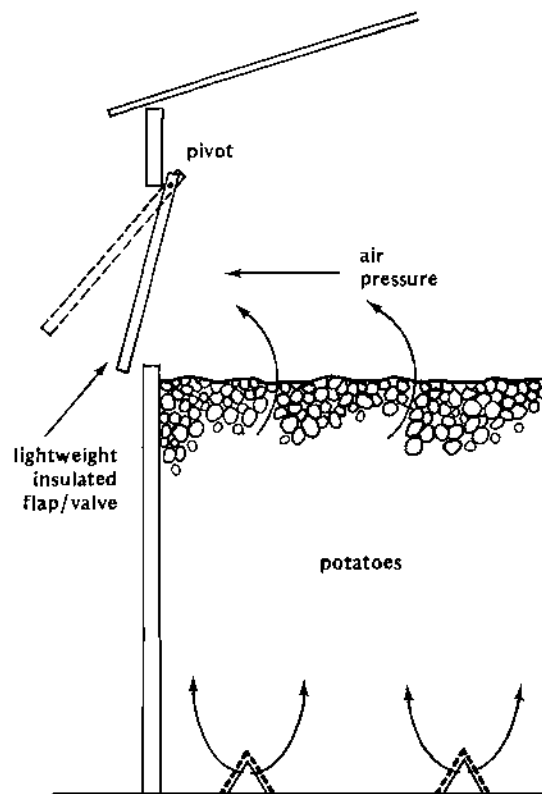

Figure 45. Exhaust ventilator (pressure relief flap). (From *Control of Environment, Part 2, Potato Marketing Board, Sutton Bridge Experimental Station, Report No. 6, London*).

stack and the top of the walls should be at least 1 m in buildings with low pitched roofs, but may be reduced in buildings with steeper roofs. Positioning air outlets in relation to inlets is important (Figure 47). Introduce air at a low level and exhaust it at a high point to maximize air flow and distribution through the tubers. Where a number of exhaust points are used they should all be equidistant from the inlet and, as in the case of a single exhaust, as far away as possible from the inlet.

Fan Choice

The choice of the correct fan is important. Suitable electric fans are of two main categories: centrifugal and axial flow (Figure 48). Generally, because back pressure in well designed potato stores is fairly low, the axial type fan is adequate and cheaper to operate. In multipurpose buildings, such as those also used for drying grain or where rapid or extensive cooling of potatoes is required, a centrifugal fan would be required. Centrifugal type fans are advisable in "tropical" conditions where ventilation requirements are usually higher. Axial flow fans are compact, easy to install and the straight-through air flow enables them to be fitted directly to a main air duct. One disadvantage is that axial fans tend to be noisier than centrifugal fans and transfer the heat from the rotor directly into the air stream. Additionally, propeller fans may be used in box stores, and to aid natural ventilation where no air duct system is involved. They are suitable for roof extraction.

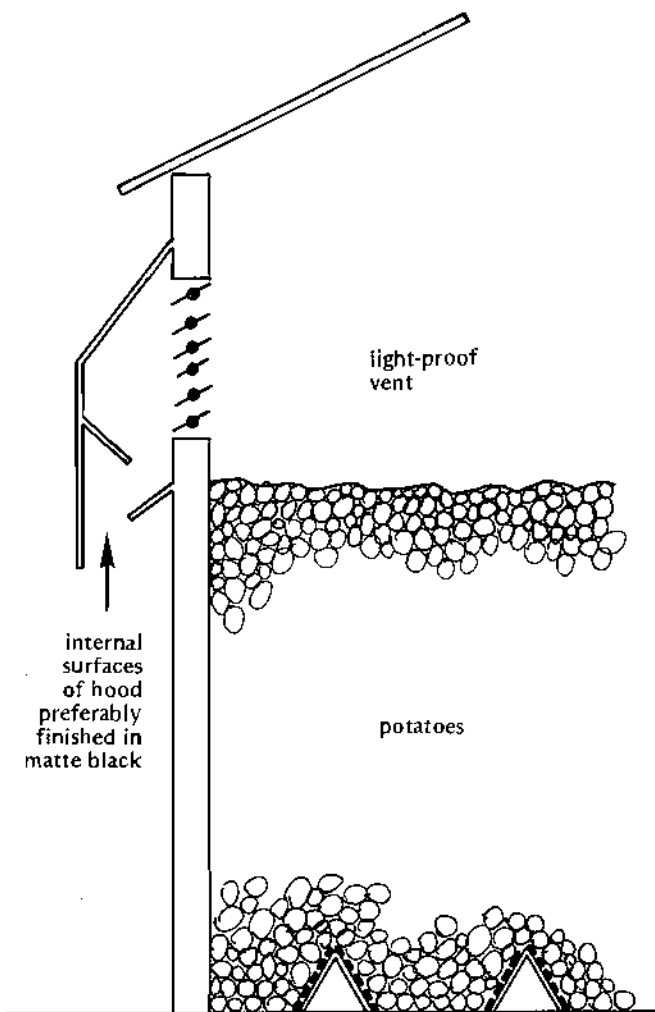

Figure 46. Exhaust ventilator (light-proof baffle). (From *Control of Environment, Part 2, Potato Marketing Board, Sutton Bridge Experimental Station, Report No. 6, London*).

Figure 47. Ventilation (air distribution). (Top drawing from *Control of Environment, Part 2, Potato Marketing Board, Sutton Bridge Experimental Station, No. 6, London*).

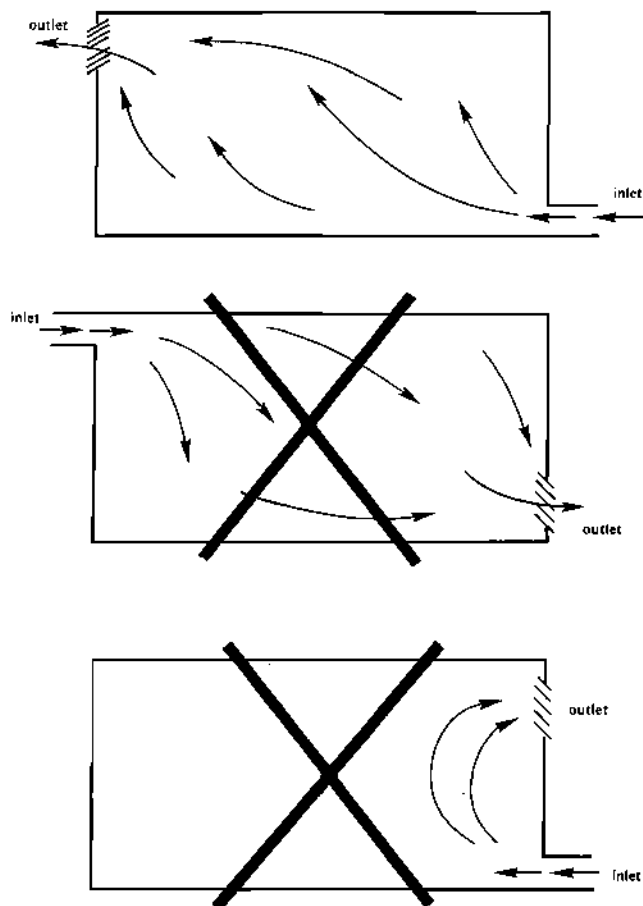
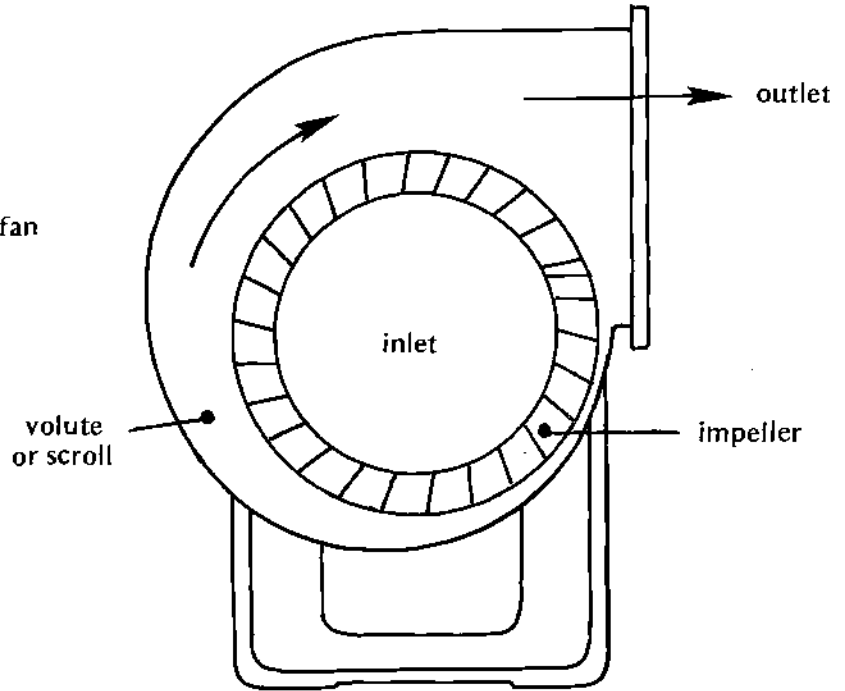
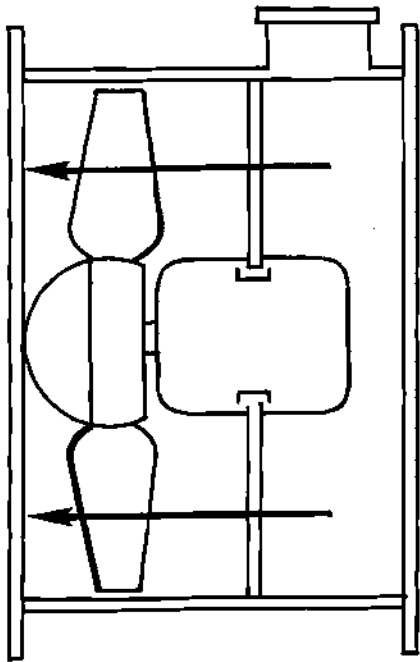

Figure 48. Three fan types, centrifugal, axial flow and propeller. (From *Control of Environment, Part 2*, Potato Marketing Board, Sutton Bridge Experimental Station, Report No. 6, London).

A – Centrifugal fan



B – Axial flow fan



C – Propeller/Extractor fan

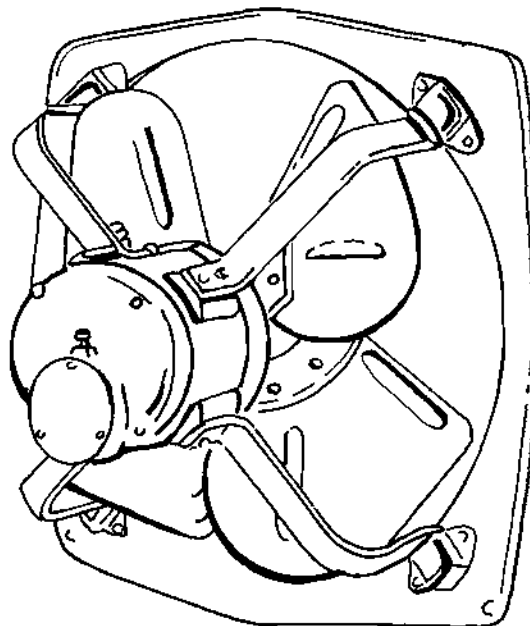

STORE MANAGEMENT

Introduction

Pre-storage Phase

Storage Phase

Drying

Curing period

Holding period

Conditioning

Chitting/pre-sprouting

Management Practices

Temperature monitoring

Humidity monitoring

Temperature control

Humidity control

Post-storage phase

STORE MANAGEMENT

Introduction

Store management is as critical to the system as are production management and marketing. Operation of the storage "reservoir" must be thorough. It requires understanding of the total production-storage-demand system in addition to detailed knowledge of potato storage technology. Proper storage management helps make the total system more efficient and less costly.

Pre-storage Phase

Even the best facilities require that only good quality tubers be stored. The most important single factor determining success or failure of the storage phase of a system is the quality of tubers placed into store. Storage management requires a knowledge of the history of the crop. Potato varieties differ considerably in important storage characteristics. These characteristics must be understood in terms of the locally produced crops.

Storage behavior also depends on growing conditions and production management and practices. Selection of growing site and land preparation partially define quality of harvested tubers. Fields improperly selected and prepared lead to subsequent difficulties in cultivation and harvest often resulting in mechanical damage that reduces storage quality of tubers. Conditions for high yield and for good storage characteristics may be contradictory. For example, high nitrogen fertility increases yield but decreases storage quality. Adequate field management in controlling pests and diseases is essential to produce storage quality tubers. Storage managers must know to which pests and diseases the crops to be stored have been exposed.

Because many problems result from what takes place during the growing season, proper field management of these pre-storage factors together with rigorous selection of tubers prior to storage are keys to good storage management. Pre-storage selection is always important but is *critical* in situations where less control over the storage internal environment is possible. In the more developed potato producing countries, labor is expensive and capital is cheap, relatively speaking, so greater emphasis is placed on reducing storage losses by using sophisticated systems that include high levels of control for internal environment. The reverse is true in lesser developed potato producing regions where it is usually impossible to build or manage sophisticated systems. Therefore major emphasis must be placed on pre-storage selection.

Knowledge of the magnitude and number of yearly production cycles is required to design and manage storage facilities. Also essential for good store design and management is detailed information on the production potential of individual producers and on the number of and storage charac-

teristics of varieties being used. Neither different varieties nor production from different farms should be mixed in bulk stores. This is a major reason for the design and management of a store for several different varieties produced by many small farmers being different from the design and management of a store required to store the same quantity of a single variety produced by a single grower.

Storage Phase

The selection of a storage environment is a compromise among many conflicting factors. The importance of individual factors is an "on-the-spot" management decision requiring knowledge of local production practices and problems, anticipated storage patterns and problems, and market and consumer demands. The following are some general guidelines upon which specific local modifications must be imposed.

Drying

Potatoes harvested under wet soil conditions must be dried immediately. Tubers that have been rained on should not be considered for storage. When a store is equipped with a fan it should be used to aid surface drying during a time when outside temperature is low. Ventilation should be at the maximum possible rate for the shortest time needed. Excessive ventilation (after removal of surface moisture) can dehydrate and soften the stored crop. Where a store is not equipped with a fan, some drying may be done in a low stack, no more than 1 m deep, by opening all ducts and roof ventilators to provide the maximum amount of convective ventilation. Under some circumstances partial field drying is possible but avoid exposing potatoes to direct sun and strong winds. Many varieties green so rapidly and easily that drying within the storage building and not in the field is essential. Frequent inspection of the crop during the drying period is essential.

Curing Period

Successful curing is essential for good storage. As soon as the potatoes have been loaded into the store, manage ventilation so that the temperature of the tubers is about 15°C. In most temperate and cool upland tropical potato growing regions, simply restricting ventilation which permits the heat of respiration to accumulate raises the temperature. Ventilation restriction also encourages development of high humidity (above 85%) essential for the curing process. Maintain these conditions for 7 to 15 days.

Conditions required for curing also favor development of several diseases, particularly bacterial soft rot. Again, careful selection is important as well as close attention to avoid potato temperatures above 20°C. Reduce temperature to the necessary holding temperature immediately following the curing period. Omit the curing period if the crop has been harvested under very wet conditions or is suspected of containing a significant proportion of bacterially infected tubers.

Holding Period

At the end of the curing period reduce temperature of potatoes to the required holding temperature. Choice of holding temperature is greatly influenced by duration of the storage period, end-use of the tubers and of varieties involved. Ranges of common holding temperatures are shown in the accompanying box.

Common Storage Holding Temperatures

Temps ($^{\circ}$ C)	Potato Type	Time
8 to 10	consumer	1 to 3 months
4 to 7	consumer	longer term
10	processing	1 to 3 months
7 to 8	processing	longer term
5 to 12	seed	1 to 3 months
2 to 4	seed	longer term

Once the temperature is at the required level, reduce ventilation to the minimum required to maintain that temperature and, in the case of bulk stored potatoes, to maintain the stack temperature differential as low as possible. Relative humidity must also be maintained at a high 90 percent during the holding period to minimize loss of moisture from the potatoes by evaporation.

Long term storage of consumer potatoes at 4° to 7° C and processing potatoes at 7° to 8° C requires the use of chemical sprout inhibitors. Considerable managerial skill and experience are required for successful use of chemical sprout inhibitors. Methods of application and managerial practices will vary according to local formulations of available chemicals, store and ventilating system designs, and external and internal storage environments.

Indirect light may in some circumstances be used instead of low temperatures to control excessive sprout growth for long term storage of seed potatoes. Natural indirect light can be used in a range of simple low cost structures which are particularly appropriate for smaller farmers.

Allow the store temperature to rise to 10° to 15° C prior to unloading stored tubers. Tubers are more susceptible to mechanical damage when handled at low temperatures.

Handle tubers gently at all stages in potato storage. Change tuber temperatures gradually, not more than 1° C per day. Depending upon field harvest temperature of tubers, 2 to 3 weeks should be taken to cool them to curing temperature and an additional 2 weeks to holding temperature. Similarly, at the end of the storage period about 2 weeks should be taken to raise temperature from holding. Physiological changes and losses are minimized with this type of management.

Conditioning

Tubers stored at low temperatures and subjected to low temperature sweetening must under-

go a conditioning period if they are destined for the processing market. They may be de-sweetened by holding for 2 to 3 weeks at a temperature of 15° to 20° C. This process involves both the reconversion of some of the free sugars to starch and the consumption of some sugars in respiration. The overall result is that sugar content decreases. However, reconditioning is rarely complete and tends to be uneven. Low temperature sweetening must not be confused with senescent sweetening, which cannot be reversed in such a manner, and which will be aggravated by these higher temperatures.

Chitting/pre-sprouting

Management designed to give optimal development of sprouts prior to planting of seed tubers is successful only if the seed can then be removed from the store, handled and planted without sprouts being knocked off or damaged. In practice, this usually means that such methods are done only by the final recipient of the seed, the grower who intends to plant it. Exact management of store temperatures and light must be determined from the dormancy period, apical dominance and sprout growth characteristics of the particular varieties being handled.

Management Practices

Successful management of the storage system requires monitoring and control of the storage environment. Temperature and relative humidity must be constantly controlled and monitored. Several alternative methods are available.

Temperature Monitoring

A fundamental of potato store management is knowing the temperature both within the store and of the outside ambient air. Outside temperatures may be measured with a simple maximum and minimum thermometer sited away from external influences, particularly direct sunlight. For measuring air temperature surrounding the potatoes (which will rarely vary more than a half degree from the internal potato temperature) either direct reading instruments or remote station indicators may be used. Glass thermometers can be used as direct reading instruments suspended within the pile of tubers 400 mm to 500 mm below the surface of the stack. The way to do this is to suspend the thermometer within a tube (a water hose, for example) with a piece of string. The string is held in position by a cork (Figure 49). The bottom of the tube is left open. Better results are obtained if the thermometer bulb is surrounded by plasticine or similar material to avoid rapid temperature changes when it is removed for reading. Use no less than one thermometer for each 50 TM of potatoes. One advantage of this type of temperature reading instrument is that it requires entry into the store for monitoring and, thus, encourages appraisal visually and by odor, both reliable indicators of potato condition in storage.

Mercury/alcohol thermometer
suspended in a tube

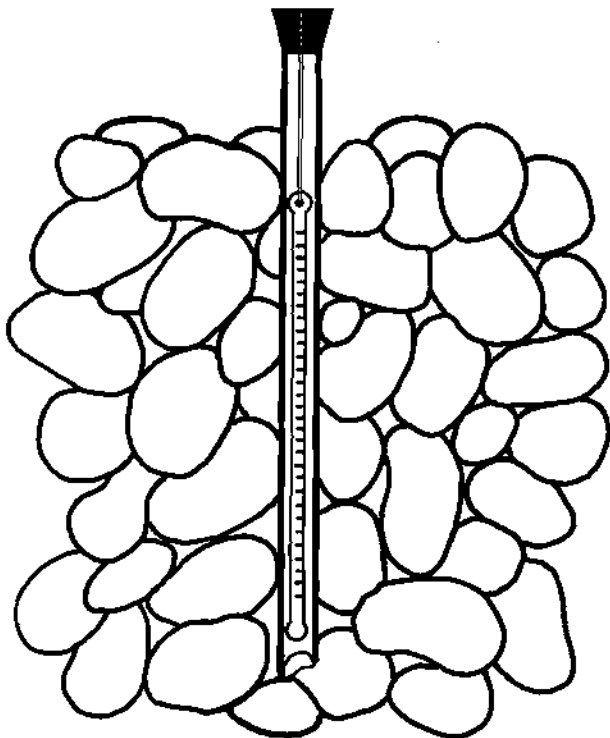

Figure 49. Simple temperature monitoring. (From *Control of Environment*, Part 2, Potato Marketing Board, Sutton Bridge Experimental Station, Report No. 6, London).

Remote station indicators use thermistors or thermocouples to transmit an electrical signal to a visual display at some convenient control point in or adjacent to the store. These devices are easy to use and place in a store. Always use some ordinary glass thermometers as a back-up and check on proper calibration.

The hottest part of a potato stack is 400 mm to 500 mm below the top surface. This temperature should always be monitored. Data from several levels is useful to determine stack temperature gradients and to pinpoint localized "hot spots." A breakdown of tubers as a result of bacterial soft rotting, for example, is invariably accompanied by a marked rise in temperature. Timely recognition of this situation means the potatoes can be moved or possibly ventilation increased to prevent spread of rotting.

Humidity Monitoring

The simplest method, and possibly the most reliable, is to use a wet and dry bulb thermometer as, for example, in a sling or battery operated psychrometer. The cooling effect of the water evaporating from a fabric sleeve surrounding the wet thermometer bulb produces one temperature reading and the difference between it and another reading from the dry bulb provides a figure from which relative humidity, dew point or vapor pressure can be calculated from psychrometric tables. In potato stores where the relative humidity should be in excess of 70 percent, the use of simple expanding/contracting cotton or hair sensing hygro-

mers is unacceptable because they are not accurate at this end of the scale.

Temperature Control

The operation of external openings or ventilators and fans may be in response to manual, semi-automatic or fully automatic signals. Manual or semi-automatic operations require considerable management and forecasting ability and are often inconvenient because a large proportion of the ventilating occurs at night. On the other hand, automation requires relatively sophisticated equipment that must be understood and maintained. However, the cost of automation can be small in relation to the cost of forced draft and refrigerated stores or the value of the crop in store. The basis for automatic control is a differential thermostat. This instrument, in the simplest form, has two temperature sensing probes, one of which is placed outside the store measuring the ambient air temperature, and the other probe is within the store sensing the stack temperature. Based on a pre-set differential (usually 2° to 3° C) a circuit closes in the thermostat that turns on the fan(s). If freezing ambient temperatures are possible, a frost-guard device will be required. For use in large stores electronic differential thermostats which have multi-point temperature sensing can be obtained. Control systems can be devised to perform virtually any requirement but must not be regarded as a substitute for good management.

Humidity Control

Periodic artificial humidification of the air, if necessary, is best applied in response to a fully automatic monitoring and control system. Manual control or the automatic coupling of humidification systems with ventilating fans can, other than in very specific conditions, easily allow saturation conditions of the air to develop with an increased risk of rotting in the stored crop.

Under normal circumstances, temperature should be considered the dominant management factor. However, under conditions of extremely low relative humidities extreme care must be taken to avoid dehydration. Under these conditions the humidity of ventilating air must be increased.

Post-storage Phase

For the system's storage phase to be successful, management must have access to market information as well as the ability to respond to this information. The need for prompt response to market information influences store location and design. Stores must have good access to both production areas and the markets they intend to supply. Properly designed and managed stores permit the principles of "first in, first out" to always be applied. Successful management of commercial stores requires that operators have their own or readily accessible transport to respond rapidly to market needs. Information on the influence of over-supply or under-supply on market prices and demand is also critical to management of tuber out-flow from the storage reservoir.

ECONOMICS OF STORAGE

Introduction

Increase in Returns

Structure Costs

Management Costs

Loading and Unloading Costs

Interest Charges

ECONOMICS OF STORAGE

Introduction

The main function of consumer potato storage is to bridge the gap in time between harvest and consumption. Where production is highly seasonal, storage aims to provide consumers with potatoes at reasonable prices throughout the year. Where production is staggered throughout the year storage requirements are minimal.

No matter who does it (farmer, cooperative, middleman or government) and no matter how simple or sophisticated is the technology used (clamps, naturally ventilated stores, or refrigerated stores), any storage system costs money. Even if no structure is used, interest is forgone on money tied up in the potatoes stored. And if a store is only partially used, or is not used at all, its construction and maintenance add to the cost of the entire production-storage-demand system. The more complex the store, the higher the investment, and it should be remembered that the most complex system is not necessarily the most cost-effective one.

In a potato production system with seasonal production and no storage the market price of potatoes may fall below production costs at harvest time, but rise very much higher later. With storage, the price at harvest may not fall below production

costs but later in the year it will not rise as high as when storage was not practiced (Figure 50). The price increase after harvest may or may not compensate for the storage investment. Storage of potatoes does not guarantee a profit, but it gives the seller-farmer or merchant-an alternative and a chance to try for a higher profit later if he so desires.

A common belief is that the entire spread between the prices received by potato farmers and those paid by consumers is profit for the middleman. Price fluctuations are often considered as signs of market imperfections and manipulations by traders. Government marketing agencies and storage schemes are often set up to provide an alternative market channel to minimize the price spread and price instability. But experiences with large scale government potato storage programs have not been promising. Many have had higher costs than those in private channels and they have generated greater price instability.

In the following paragraphs storage is discussed as an option for the private farmers or merchants. However, the same principles apply for cooperative or government run stores.

The individual farmer may sell all his crop off the field, store it all, or sell and store in varying proportions. In addition to technology, financial factors to be considered in selecting among storage alternatives include availability of working and long-term capital for investment in storage systems and the rates of return these may give on the capital invested.

Assuming that no storage is practiced at present, the expected change in profit (ΔP) from storage may be calculated by subtracting from the

Figure 50. Effect on prices of cyclical production with and without storage.

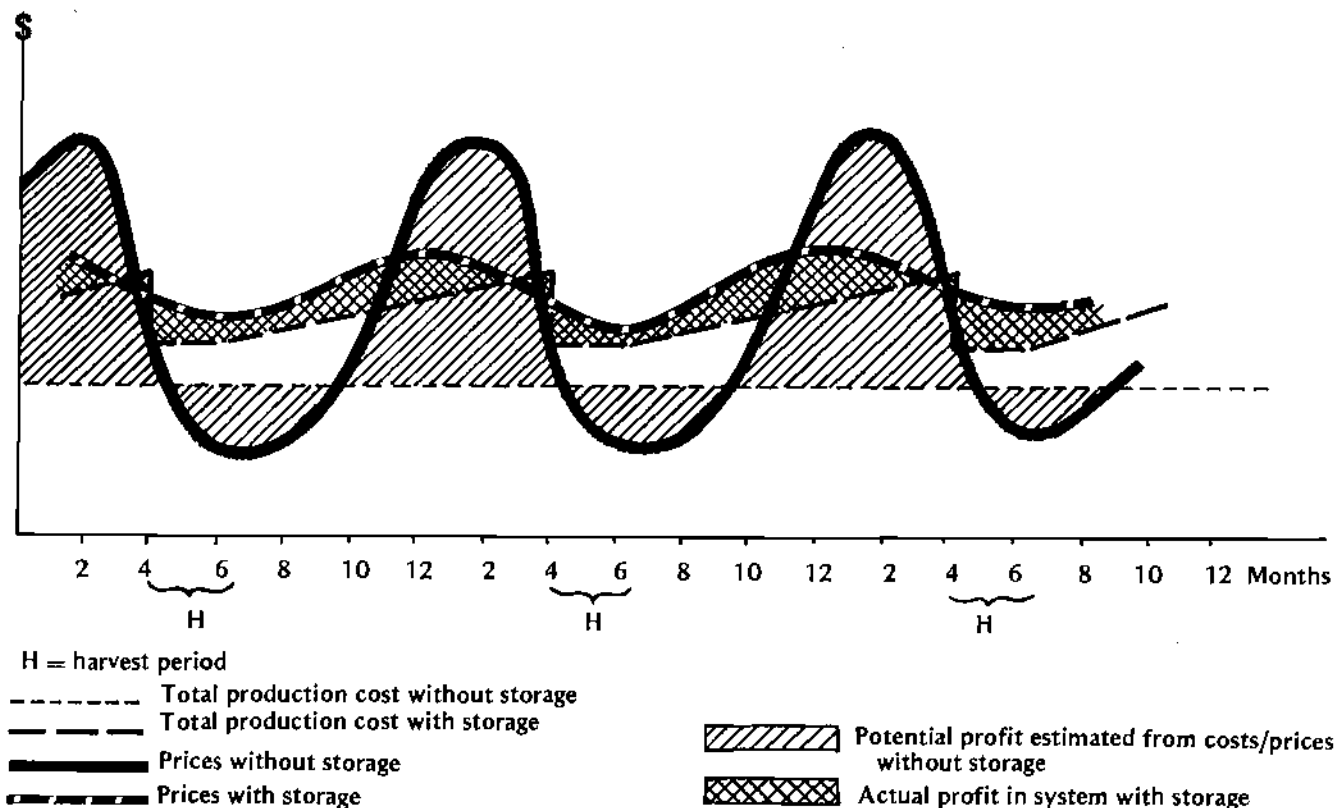

expected increase in returns (ΔR) costs of the structure (S), store management (M), handling (H), and interest (I).

$$\Delta P = \Delta R - S - M - H - I$$

Increase in Returns (ΔR)

The change in returns is the difference in value of the produce at the beginning and end of the storage period. In other words, the increase in returns (ΔR) from storage is equal to the tonnage taken out of store (Q_2) multiplied by the average value per ton taken out (V_2) minus the tonnage placed in store (Q_1) times its average value (V_1).

$$\Delta R = (Q_2 \times V_2) - (Q_1 \times V_1)$$

Increased returns from potato storage are affected by the total situation under which the potatoes are grown, stored and marketed. For accurate assessment of returns, the tonnage placed into and taken out of the store must be separated into various economic categories such as consumer, stockfeed and waste quality tubers, each of which has a different price or value. The following example illustrates the calculation of increased returns to a farmer due to storage:

1. Potatoes put into store:

Quality	Quantity	Unit Price	Value
Consumer	850	30	25,500
Stockfeed	150	4	600
Waste	0	0	0
Total	1,000		26,100

2. Potatoes taken out of store:

Quality	Quantity	Unit Price	Value
Consumer	750	40	30,000
Stockfeed	150	5	750
Waste	100	0	0
Total	1,000		30,750

$$\text{Change in returns} = 30,750 - 26,100 = 4,650$$

Three major factors influence returns from storage: (1) increased prices, (2) loss of potato quality in store and (3) changing proportions of consumer, stockfeed and waste tubers placed into and taken out of the store. What is considered consumer and stock feed quality and what is thought of as storage losses varies from region to region, season to season, and among different farming groups within the same region or season. A small subsistence farmer's idea of storage losses is likely to be quite different from the view of a large commercial farmer and what is acceptable to consumers will vary with season and location. Such differences must be considered during the selection of appropriate and economic storage systems.

Information must be obtained on market prices and annual price trends and patterns. Stability and predictability of these patterns strongly affect the risks involved in storage. The influence of storage practices on future market price movements also should be anticipated before appraising the potential profits from the system using storage. Similarly, information is necessary regarding sensitivity of the supply-price relationship. To manage the storage reservoir successfully we must know to what extent over-supply or under-supply influences prices.

In general, well stored potatoes with a good appearance bring above-average market prices. In markets where consumers are more selective, quality has an increasingly important effect on price. One way to consistently increase returns from storage is to always aim at marketing high quality tubers. This requires an understanding of the varying quality needs of consumers.

For example, blemish diseases, such as silver scurf, which influence the appearance of the tubers, may be of little economic importance in traditional markets but may be crucial in more sophisticated markets, especially where potatoes are sold washed and pre-packed in see-through bags. The reverse may be true for specific cooking qualities which are often more important in traditional markets.

The percentage of consumer potatoes taken out of a store is influenced by two factors: (1) the percentage of consumer potatoes stored, and, (2) loss of consumer-quality tubers during storage. The first factor is largely influenced by the level of pre-storage grading and selection. Factors contributing to loss during storage have been discussed previously in this publication. A minimum loss of consumer quality tubers ranges from 5 percent to 15 percent even in good stores with proper management. This loss will be much greater unless care is taken to minimize damage, and under poorer storage conditions and management. Obviously, the higher the price of consumer potatoes the greater the financial loss from a given loss in the quantity of consumer quality tubers.

Structure Costs

Structure costs can be subdivided into capital investment and annual structure maintenance costs. Certain types of simple stores, such as clamps or pits, involve little or no fixed capital investment. Modification of existing farm buildings for potato stores have fairly low investment requirements, but relatively high annual expenditure in such items as straw for insulation. Specially constructed stores involve a much greater long-term investment and smaller annual expenditure, especially in bulk stores.

Besides the level of capital investment it is also important to consider the type of capital required. Stores involving substantial fixed investment require a confident view of the long-term profitabil-

ity of growing and storing potatoes. Stores with only a short-term investment requirement allow farmers the possibility of storing or not storing depending on production and market conditions.

Use of existing buildings limits the type and size of the store, the method of store management and loading and unloading systems. Annual structure costs may involve such items as straw insulation, ventilating ducts, polythene, boxes and labor. When calculating labor costs the "opportunity costs" should be estimated on a whole farm-family basis. In some cases, where the farmer has other pressing work requirements the going market wage may be far below the real opportunity costs and the reverse may be true with permanently employed labor during periods of low work load. Thus, timing of operations relative to the total farm-family system is vital to keep opportunity labor costs low.

Store Management Costs

Store management costs tend to increase with the degree of sophistication of the ventilating system. For simple field clamps, both fixed and variable management costs are low. More sophisticated or complex stores using recirculation of refrigerated air have both high fixed and variable costs in provision, maintenance, and running of the necessary equipment. As the degree of complexity increases, the management and maintenance skills required to operate the systems also increase. Availability and costs of such skills must always be taken into account in planning and budgeting of storage operations.

Loading and Unloading Costs

Loading and unloading costs include the opportunity cost of labor and the capital, operational and maintenance costs of essential equipment. Where mechanized equipment is used, a major factor affecting costs is the quantity of potatoes moved with the equipment. For example, for potatoes stored in boxes, two half-ton boxes cost more than a single one-ton box and they also require twice as much handling.

Interest Charges

Interest charges on all capital employed in potato storage systems must be included in the financial appraisal of the system. Relatively little short-term working capital is involved in storage structures, store management and loading and unloading, although this will generally increase with the sophistication of the buildings and equipment used. The *value of the potatoes stored* is far more significant, particularly where large quantities are involved. Thus, the interest which could have been earned on money received from the immediate sale of the crop should be considered as an opportunity cost. With very small producers frequently the timing of cash availability is more important than the interest factor and in many situations this can be an overriding factor in the decision as to whether or not to store.

Once potatoes have been put into a store most of the costs have been incurred. It is thus best to store potatoes as long as possible, providing the running costs, interest charges, and increases in tuber losses are more than covered by the market price increases.

For successful management of commercial stores the operators must have adequate information on price movements and supply/demand conditions in their market. Operators must also have their own, or readily accessible, transport to convey the stored crop to market at opportune times. In addition, the extent to which over- or under-supply influences market prices should be known. The wide range of potato storage systems, which are more or less technically appropriate in a given situation, makes it possible to select a system which makes optimal use of available capital and management expertise.

The above discussion emphasizes that any storage system, no matter how simple, costs money. Where storage is required to meet consumer demands, the consumers or their supporters must be prepared to pay for storage system costs required to bridge the seasonal production gaps and to provide a necessary profit incentive.

An example of a methodology of evaluating an improved seed storage system against existing farmer practices is given in Appendix A6.

APPENDICES

- A1 Conversion Factors**
- A2 Insulation and Insulation/Condensation**
- A3 Psychrometric Charts**
- A4 Refrigeration Equipment**
- A5 Post-harvest Pests, Diseases and Disorders**
- A6 On-farm Evaluation of Seed Stores**

CONVERSION FACTORS

Appendix 1

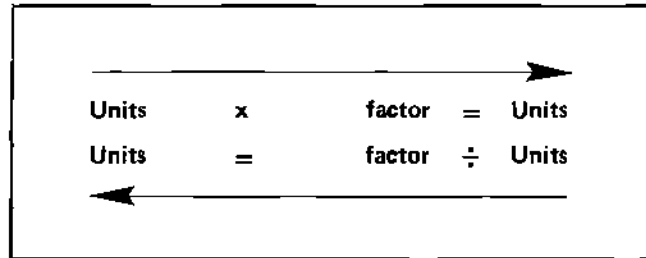

Length

inch	2.54	centimeters
foot	30.5	centimeters
yard	0.914	meters
mile	1.61	kilometers

Area

square inch	6.45	square centimeters
square inch	0.0929	square meters
square yard	0.836	square meters
square mile	2.59	square kilometers
acre (4840 sq. yd.)	0.405	hectare

Weight/Area

cwt/acre	112.2	kg/ha
ton/acre	2.23	tons metric/ha

Density

pound/cubic foot	16.02	kg/cubic meter
------------------	-------	----------------

Velocity

foot/second	0.305	meters/second
foot/minute	0.0051	meters/second
mile/hour	1.61	kilometer/hour

Flow

cubic foot/second	0.028	cubic meters/second
cubic foot/minute	1.70	cubic meters/hour

Volume

cubic inch	16.4	cubic centimeters
cubic foot	28.4	cubic liters
cubic yard	0.765	cubic meters
gallon (U.S.)	3.78	cubic liters
gallon (imperial)	4.55	cubic liters

Weight

ounce	28.4	grams
pound	0.454	kilograms
ton (2,000 lb)	0.908	tons metric

Temperature

(°F - 32)	x	0.56	°C
(°C x 1.8)	+	32	°F

Heat

British Thermal Unit	1055	joules
kilocalorie	4187	joules
kilocalorie	3.97	BTU
horsepower hour	2,685,000	joules
kilowatt hour	3,600,000	joules

Heat flow

BTU/hour	0.293	joules/second
BTU/hour	0.252	kilocalorie/hour
kilocalorie/hour	1.163	joules/second
horsepower	746	joules/second

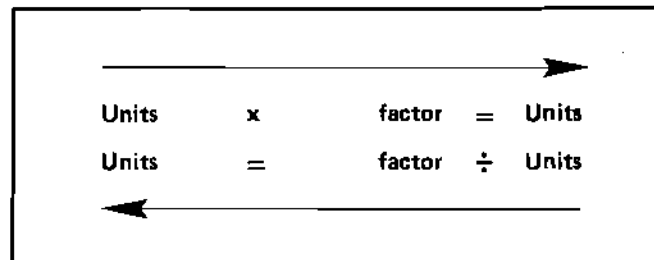

Refrigeration

ton refrigeration	3516	joules/second (watts)
	12000	BTU/hour
	12658	kilojoules/hour

Insulation

(*k*) values

$\frac{\text{BTU} \times \text{in}}{\text{ft} \times \text{hr} \times ^\circ\text{F}}$	0.144	$\frac{\text{Joules}}{\text{sec} \times \text{m} \times ^\circ\text{C}}$
--	-------	--

(*U*) value

$\frac{\text{BTU}}{\text{ft}^2 \times \text{hr} \times ^\circ\text{F}}$	5.68	$\frac{\text{Joules}}{\text{sec} \times \text{m}^2 \times ^\circ\text{C}}$
---	------	--

Heat Content

$\frac{\text{BTU}}{\text{lb}}$	2236	$\frac{\text{Joules}}{\text{kilogram}}$
$\frac{\text{BTU}}{\text{lb}}$	0.56	$\frac{\text{kilocalorie}}{\text{kilogram}}$

Light/Radiation

foot candle	0.108	lux
$\frac{\text{lumen}}{\text{foot}^2}$	0.108	lux
$\frac{\text{watt}}{\text{m}^2}$	0.317	$\frac{\text{BTU}}{\text{ft}^2 \times \text{hr}}$

INSULATION

Appendix 2

	(k)	Thickness for	
	$\frac{\text{kJ}}{\text{hr} \times \text{m} \times ^\circ\text{C}}$	(U) = $\frac{2.2 \text{ kJ}}{\text{hr} \times \text{m}^2 \times ^\circ\text{C}}$	$\frac{5.8 \text{ kJ}}{\text{hr} \times \text{m}^2 \times ^\circ\text{C}}$
Urethane	.09	.04 m	.016 m
Polystyrene	.12	.05	.021
Fiber Glass	.14	.06	.024
Sawdust	.29	.13	.05
Air Space	.43	.20	.07
Plywood	.50	.23	.09
Hardwood	.54	.25	.09
Cinder Block	.86	.39	.15
Adobe	1.8	.82	.31
Brick	2.6	1.2	.45
Concrete	4.7	2.1	.81
Sandstone	4.7	2.1	.81
Granite	9.0	4.1	1.6

Air-to-wall boundary layers should be considered when calculating (U) values, thermal transmittance, for the walls of the storage.

For interior walls (R) = $\frac{.061 \text{ hr} \times \text{m}^2 \times ^\circ\text{C}}{\text{kJ}}$

For exterior walls:

Wind Still (R) = $\frac{.033 \text{ hr} \times \text{m}^2 \times ^\circ\text{C}}{\text{kJ}}$

Wind, 5 m per sec. =	.009
10 m per sec. =	.005
15 m per sec. =	.004
20 m per sec. =	.003

NOTE: 1. The thickness for insulation materials does not consider these air boundary layers. Therefore, the calculated thickness will be slightly smaller when these layers are taken into consideration.

2. These are average values. Values from different sources will vary.

Air-to-wall boundary layers should be considered when calculating (U) values; thermal transmittance, for the walls of a store. Wind exposure can defeat the purpose of calculated (U) values, particularly in the case of poorly insulated buildings. It follows that site exposure for a potato store should not be ignored when determining levels of insulation. Information to assist in these calculations

can normally be obtained from the local meteorological station.

For interior walls: (R) = $\frac{.061 \text{ hr} \times \text{m}^2 \times ^\circ\text{C}}{\text{kJ}}$

For exterior walls: (R) has the following values,

Wind parallel to surface	Nature of Surface		
	Timber	Concrete	Brick
Wind still	.033	.033	.033
5 meters/second	.009	.007	.006
10 meters /second	.005	.004	.003
15 meters/second	.004	.003	.002
20 meters/second	.003	.002	.002

INSULATION/CONDENSATION

Control of evaporative losses from stored potatoes requires a minimal vapor pressure deficit of the storage atmosphere. Typically a RH percentage of 98 percent gives equilibrium conditions with no evaporative weight loss. The consequence of maintaining such a high relative humidity is that the dew point is frequently above the external ambient air temperature. Under these conditions condensation can occur on the inside face of the store walls and roof. If this condensate drops onto the potatoes, there is a danger of rapid spread of diseases.

The following table gives the (U) values required to overcome this risk of condensation.

(U) Values $\frac{\text{kJ}}{\text{hr} \times \text{m}^2 \times ^\circ\text{C}}$ Required to

Overcome Condensation

Percent RH	Maximum Temperature Difference		
	16.5	22.0	28.0
80	7.2	5.5	4.3
85	5.3	4.1	3.3
90	2.4	1.6	1.4

(Appendix 2, concluded)

The table shows that where potato store air temperature is approximately 10°C with an outside temperature of -6.7°C and the relative humidity of air within the store is 90 percent, a (U) value of $2.4 \text{ kJ/hr} \times \text{m}^2 \times ^{\circ}\text{C}$ is needed to prevent condensation. In practice, cold bridges in the structure are a problem, forming focal points on which condensation forms and drips back onto the crop. Great care is needed during construction to ensure continuity of insulation, particularly around fittings, main frame members and fixings. In reality most structures never prevent condensation completely and a surface covering of straw is used to absorb condensation which has formed and dripped onto the stack.

Temperature differences in naturally ventilated stores in tropical countries are usually only a few degrees and condensation does not normally occur. Where mechanical refrigeration is used, adequate insulation, preferably protected on both sides by a vapor barrier, should be provided to reduce the risk of condensation.

Psychrometric Charts

Appendix 3

(see next 5 pages)

Page 83 – Barometric Pressure 101.325 kPa, Sea Level.

Page 85 – Barometric Pressure 92.600 kPa, 750m above Sea Level.

Page 87 – Barometric Pressure 84.600 kPa, 1500m above Sea Level.

Page 89 – Barometric Pressure 77.100 kPa, 2250m above Sea Level.

Page 91 – Barometric Pressure 70.100 kPa, 3000m above Sea Level.

(Charts reproduced by permission).



PSYCHROMETRIC CHART

NORMAL TEMPERATURES

SI METRIC UNITS
 Barometric Pressure 101.325 kPa
 SEA LEVEL

Pressure in millibars of the water vapor contained in saturated air
 (1 mbar = 100 N/m²)

Temp °C	0	1	2	3	4	5	6	7	8	9
0	6.08	6.53	7.01	7.53	8.07	8.65	9.27	9.93	10.63	11.37
10	12.16	12.89	13.87	14.81	15.81	16.86	17.97	19.15	20.39	21.70
20	23.09	24.36	26.11	27.74	29.46	31.28	33.19	35.21	37.33	39.56

Maximum acceptable weight loss in potatoes is 10%. Quality and appearance are increasingly affected after 5% loss.

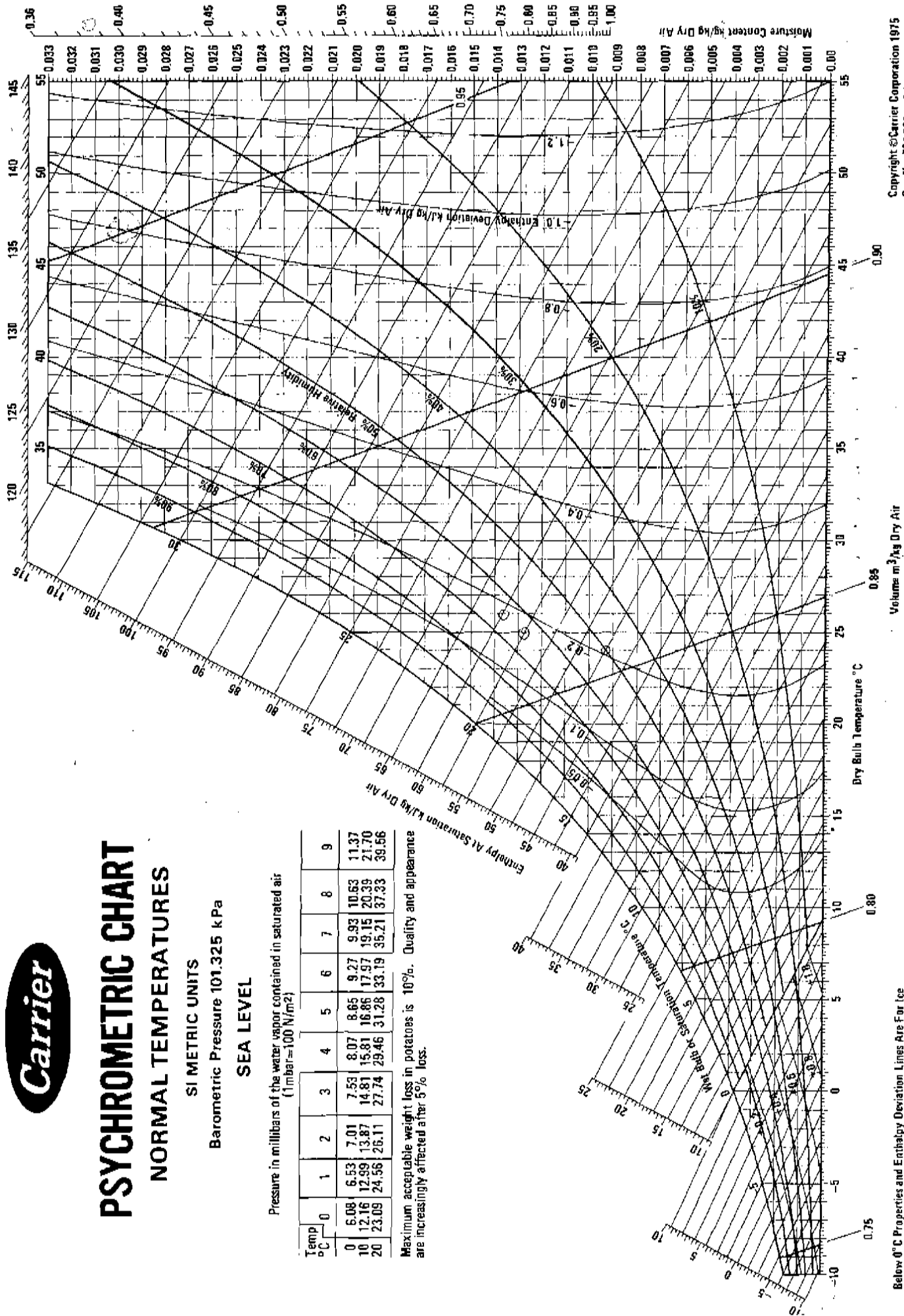



PSYCHROMETRIC CHART

NORMAL TEMPERATURES

SI METRIC UNITS

Barometric Pressure 92.600 kPa

750m Above Sea Level

Pressure in millibars of the water vapor contained in saturated air
(1 bar = 100 N/m²)

Temp °C	1	2	3	4	5	6	7	8	9
0	6.08	6.53	7.01	7.53	8.07	8.65	9.27	9.93	10.63
10	12.16	12.89	13.87	14.81	15.81	16.86	17.97	19.15	20.39
20	23.03	24.56	26.11	27.74	29.46	31.28	33.19	35.21	37.33

Maximum acceptable weight loss in potatoes is 10%. Quality and appearance are increasingly affected after 5% loss.

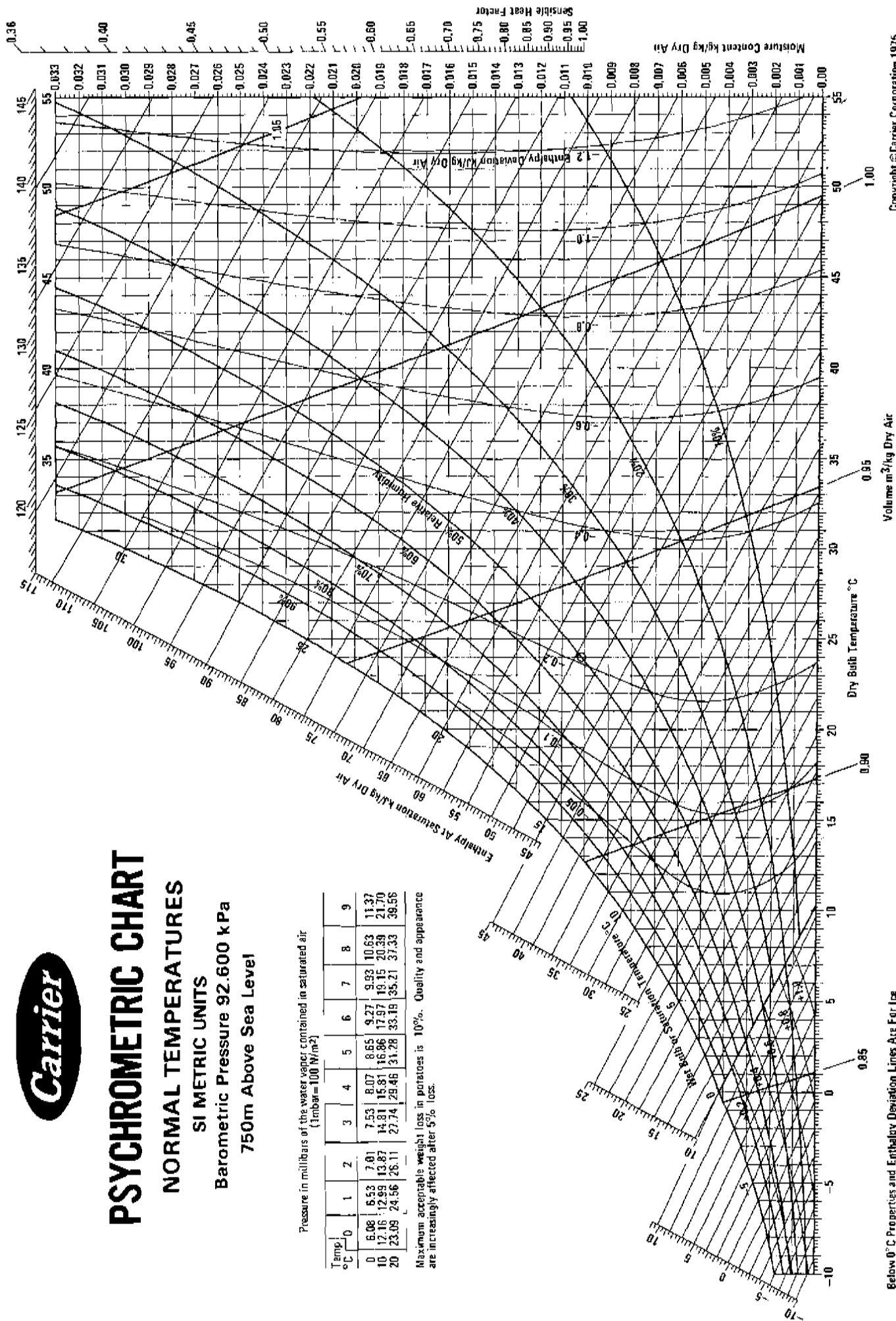

Below 0°C Properties and Enthalpy Deviation Lines Are For Ice

Volume m³/kg Dry Air

Copyright © Carrier Corporation 1975
Cat. No. 794-0016 Printed in U.S.A.



PSYCHROMETRIC CHART

NORMAL TEMPERATURES

SI METRIC UNITS

Barometric Pressure 84.600 kPa
1500m Above SEA LEVEL

Pressure in millibars of the water vapor contained in saturated air
(1 bar = 100 N/m²)

Temp °C	1	2	3	4	5	6	7	8	9
0	6.88	7.01	7.53	8.07	8.65	9.27	9.93	10.63	11.37
10	12.16	12.99	13.87	14.81	15.81	16.86	17.97	19.15	20.39
20	23.09	24.56	26.11	27.74	29.46	31.28	33.19	35.21	37.33
									39.56

Maximum acceptable weight loss in potatoes is 10%. Quality and appearance are increasingly affected after 5% loss.

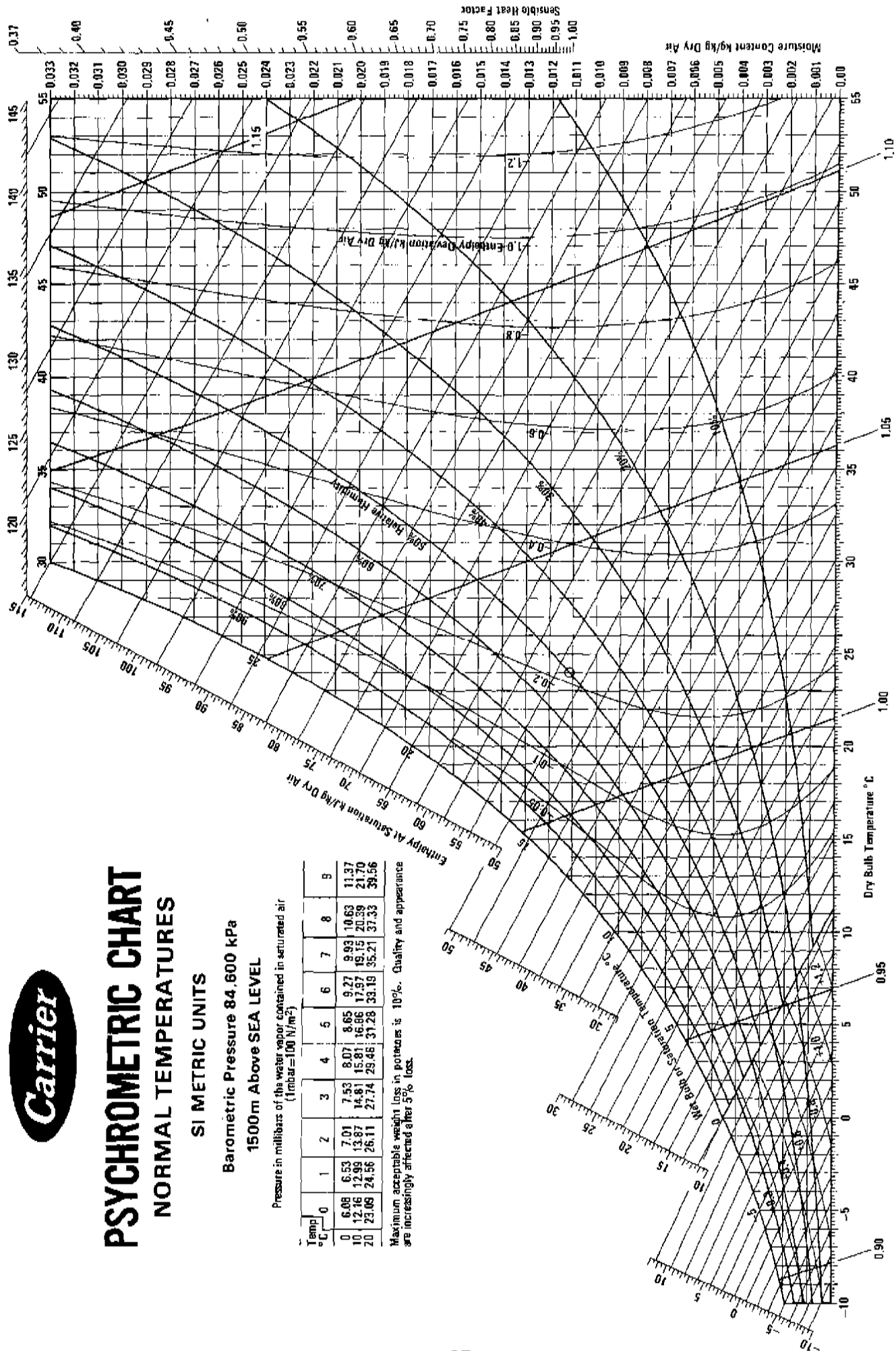

Below 0°C Properties and Enthalpy Deviation Lines Are For Ice

Volume m³/kg Dry Air

Copyright ©Carrier Corporation 1975
Cat. No. 794-007 Printed in U.S.A.



PSYCHROMETRIC CHART

NORMAL TEMPERATURES

SI METRIC UNITS

Barometric Pressure 77.100 kPa

2250m Above SEA LEVEL

Pressure in millibars of the water vapor contained in saturated air
(1mbar=100 N/m²)

Temp °C	0	1	2	3	4	5	6	7	8	9
0	6.08	6.53	7.01	7.53	8.07	8.65	9.27	9.93	10.63	11.37
10	12.16	12.98	13.87	14.81	15.81	16.86	17.97	19.15	20.39	21.70
20	23.09	24.55	26.11	27.74	29.46	31.28	33.19	35.21	37.33	39.56

Maximum acceptable weight loss in potatoes is 10%. Quality and appearance are increasingly affected after 5% loss.

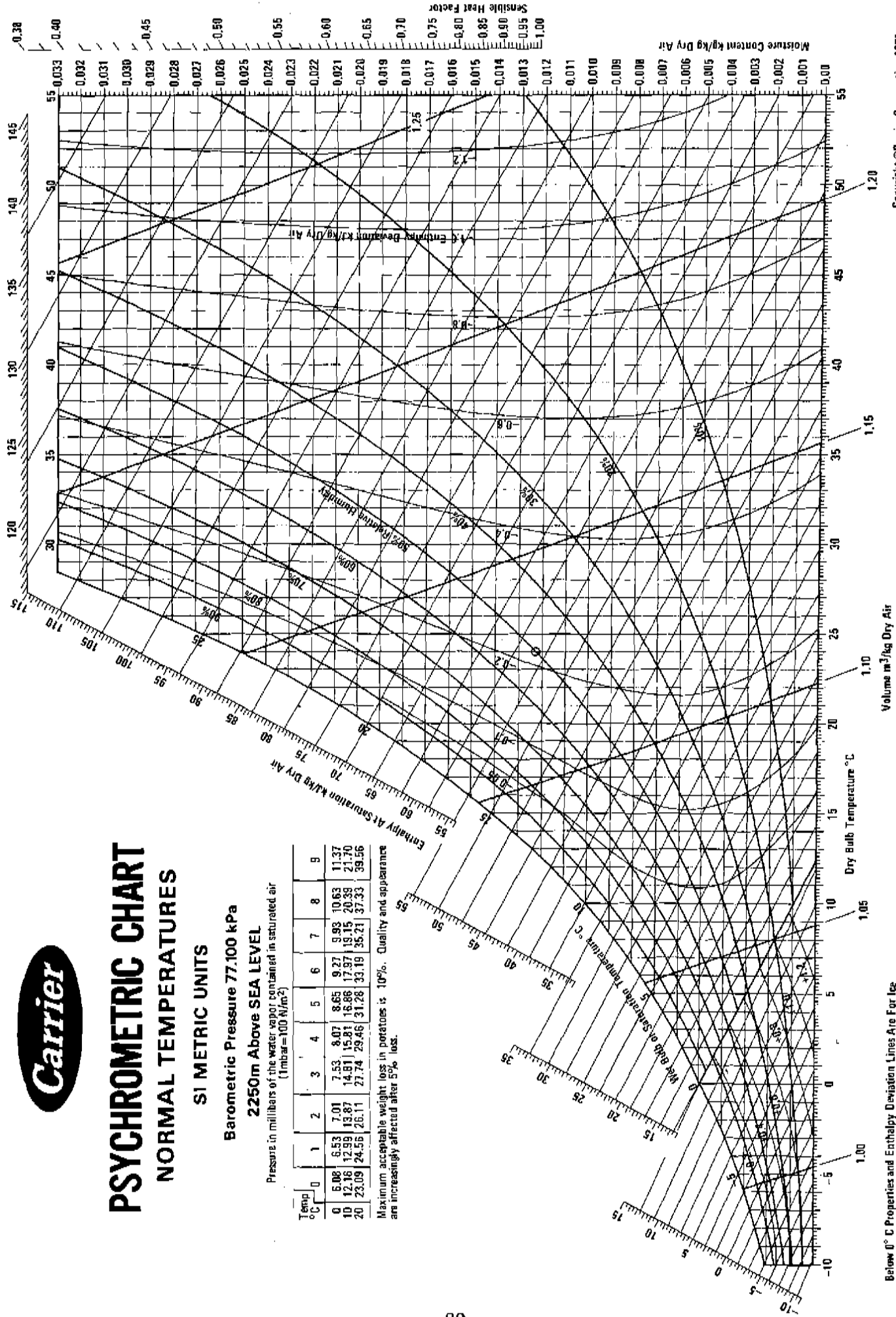

Below 0° C Properties and Enthalpy Deviation Lines Are For Ice

Volume m³/kg Dry Air

Copyright ©Carrier Corporation 1975
Cat. No. 794-608 Printed in U.S.A.



PSYCHROMETRIC CHART

NORMAL TEMPERATURES

SI METRIC UNITS

Barometric Pressure 70.100 kPa
3000m Above SEA LEVEL

Pressure in millibars of the water vapor contained in saturated air
(1 mb = 100 N/m²)

Temp °C	0	1	2	3	4	5	6	7	8
0	6.08	6.53	7.01	7.53	8.07	8.65	9.27	9.93	10.63
10	12.16	12.99	13.87	14.81	15.81	16.86	17.97	19.15	20.39
20	23.09	24.56	26.11	27.74	29.46	31.28	33.19	35.21	37.33

Maximum acceptable weight loss in potatoes is 10%. Quality and appearance are increasingly affected after 5% loss.

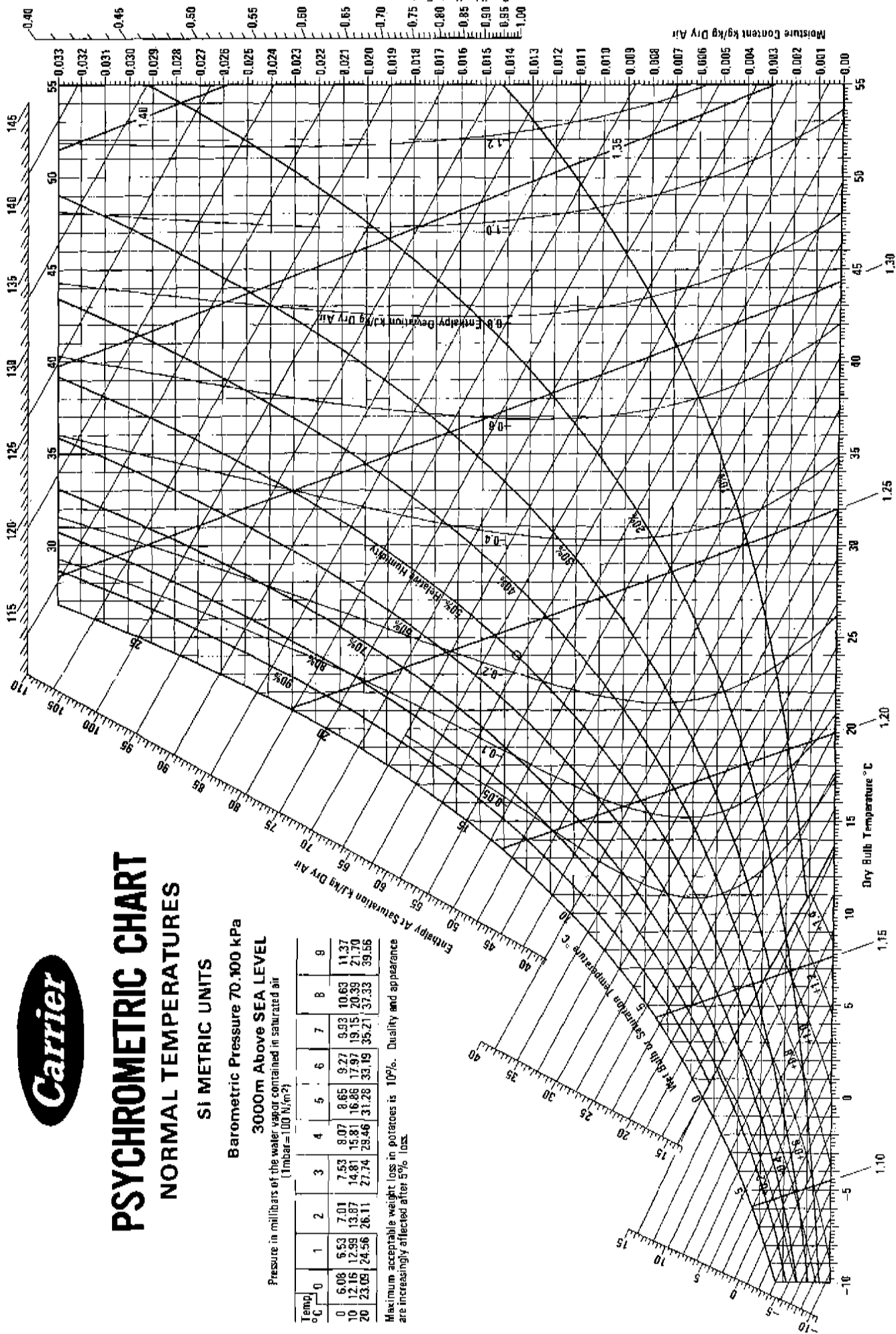

Below 0° C Properties and Enthalpy Deviation Lines Are For Ice

Copyright © Carrier Corporation 1975
Cat. No. 794-009 Printed in U.S.A.

Refrigeration Equipment

Appendix 4

Refrigeration is the process of removing heat from the storage space. The amount of refrigeration is the quantity of heat removed. The standard units of refrigeration are Watts or Btu/hour. Another common unit is *ton refrigeration* in which 1 ton refrigeration = 3,516 watts = 12,000 Btu/hr = 12,658 kJ/hr.

Refrigeration systems consist of four principle components functioning in a closed cycle (Figure 51): (1) compressor, (2) condenser, (3) expansion valve, and (4) evaporator. Sometimes the last two function as a single component.

Figure 51. Refrigeration systems (generalized diagram). (From *Control of Air Conditions in Horticultural Stores*, Mechanization Leaflet No. 12, Ministry of Agriculture, Fisheries and Food, London).

The compressor compresses the refrigerant vapor and delivers it to the condenser where the vapor is cooled and caused to liquify. The liquid refrigerant passes through a regulator valve into an evaporator which is at a lower pressure. The refrigerant boils under the reduced pressure, absorbing heat from the material surrounding the evaporator. The vapor then returns to the compressor to be used again.

Components of the Refrigeration System

Compressing and condensing sets. Positive displacement single stage compressors are used exclusively in agricultural and horticultural storage work. Direct drive by electric motor is most com-

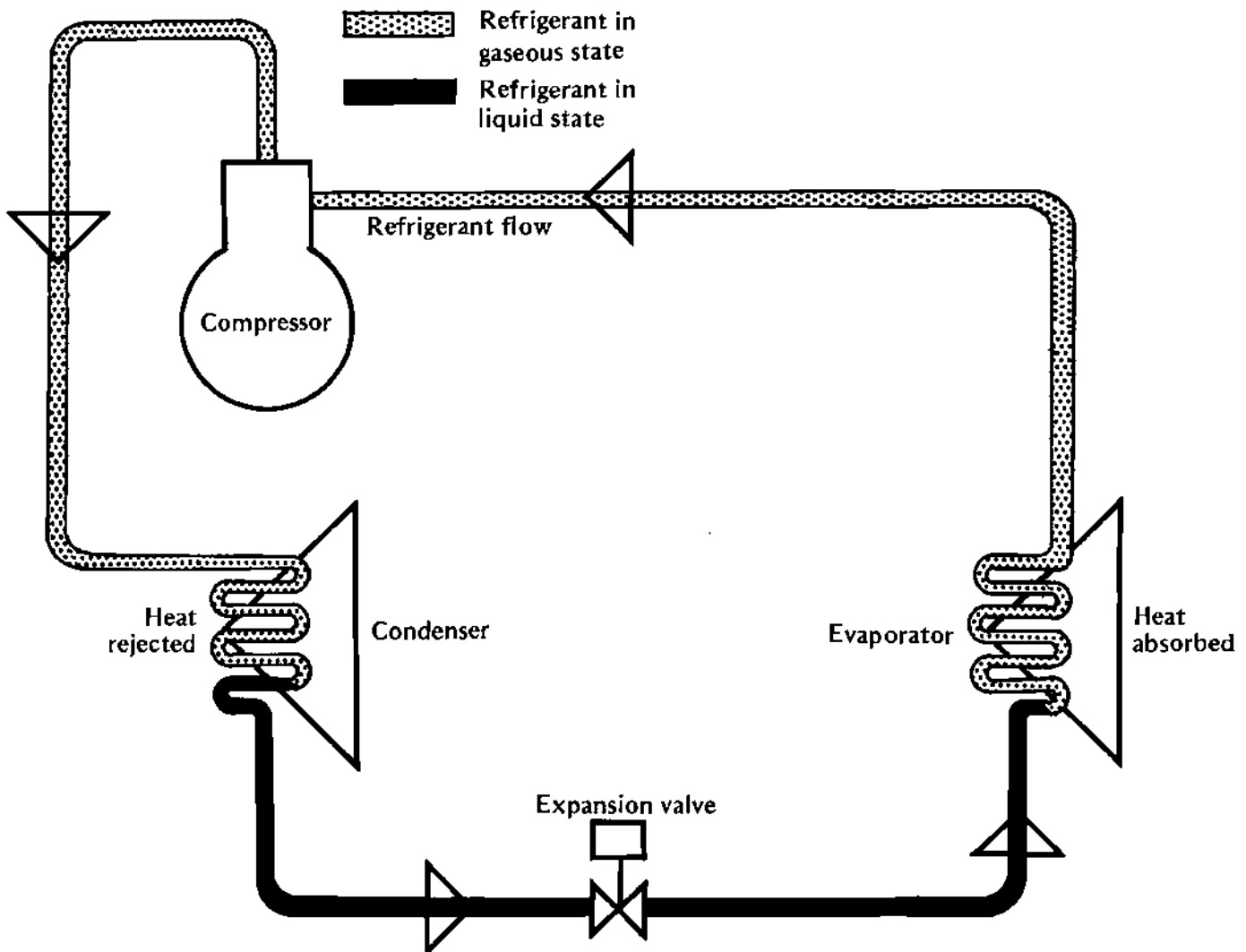

mon although some machines are belt driven. Multi-cylinder compressors with a capacity of more than 15 to 20 kilowatts (51,000 to 68,000 Btu/hr or 54,000 to 77,000 kJ/hr) will often have unloading facilities to permit a reduction in refrigeration capacity once the cooling phase has been completed. In the range below 15 kilowatts refrigeration (51,000 Btu/hr or 54,000 kJ/hr) hermetic or semi-hermetic compressors are most commonly used. The compressor unit is often mounted in a frame which also carries the liquid receiver, filter/drier, sight-glass and the condensing coil together with its cooling fan. Such a unit is called a condensing set. When specifying the cooling capacity of a condensing set, it is essential to state the condensing and evaporating temperatures to which the capacity applies. The cooling power of a condensing set varies considerably at different temperatures. For this reason, the size of the compressor motor can only be considered as a guide to plant capacity.

Condensing sets function most effectively when mounted in clean, cool positions. Although space and pipe work may be saved by installing the plant on the roof of the stores, this is not recommended. Such a site is difficult of access for maintenance and cleaning, the air temperature is often well above ambient, vibration may damage gas barriers and the weight requires extra support.

Two types of remote condensers are available. The air cooled condenser consists of a finned tube block and a fan which blows air over it. This simple low cost arrangement is generally used on medium and small sized plants. The alternative, a water-cooled condenser, is more expensive but is often preferred on larger plants because of the increased efficiency of the refrigeration system which results from the lower condensing temperature obtained. Water-cooled condensers provide greater flexibility in positioning since they need not be located near a good supply of cooling air. It is generally necessary to economize in the use of water; for this reason, it will be necessary to recirculate the cooling water through a cooling tower. Water-cooled condensing is generally only considered economic for refrigeration plants rated at more than 50 kilowatts (170,000 Btu/hr or 80,000 kJ/hr). With water-cooled systems precautions must be taken to prevent possible frost damage.

The pressure reducing process. As the compressor withdraws the refrigerant vapor from the evaporator, the cooling unit must be supplied with more low temperature, low pressure refrigerant capable of absorbing heat. This is accomplished by a liquid control valve known as an expansion valve. This valve reduces the pressure of the high pressure liquid from the receiver to a low pressure liquid capable of absorbing heat; it maintains a constant supply of liquid in the evaporator and acts as a dividing point between the high and low pressure side of the system.

In other words, freon R-12 at 39°C and 126 pounds pressure will be in a liquid state. If this pressure is reduced to 21 pounds the temperature

of R-12 will be -7°C, and each pound of R-12 will pick up approximately 53 kJ of heat of vaporization as this pressure is reduced.

There are a great number of different types of pressure-reducing devices which a design engineer may utilize to bring about the proper refrigeration effect.

The latent heat of vaporization of some of the commonly used refrigerants is as follows:

Freon R-12	165.9 kJ per kg
Freon R-22	233.5 kJ per kg
Freon R-502	177.7 kJ per kg
Ammonia R-717	1324.0 kJ per kg

Vaporizing process. The vaporizing process must take place in some type of evaporator or cooling coil.

Regardless of the type of evaporator used, the relative humidity inside the storage room is governed primarily by the difference in temperature between the air that enters the evaporating surface area and the temperature of the air that leaves the evaporator.

If we assume that the air leaving the evaporator is near 100 percent relative humidity, theoretically, entering air cannot be more than 2°C warmer than leaving air if 92 percent relative humidity is to be maintained in the storage room. If the temperature drop is greater than the 2°C, theoretically, the evaporator will extract more moisture from the air, and the desired high humidity will be unobtainable. Under any circumstances, evaporator design selection must be predicated on entering and leaving air temperatures to obtain desired humidities in a store.

The shape and size of the cooling coil also has a considerable effect on the relative humidity at which the store atmosphere can be maintained. Experience has shown that if a high relative humidity is to be maintained, the cooler must have a large surface area. This surface area should be arranged in such a way that the majority of the air passing through the cooler contacts the cooling surface. This is achieved by selecting a coil with six or more rows of tubes in the direction of air flow. To provide a sufficiently large surface area within the confined space allowed for the cooling coil, it is necessary to use finned tubes. The spacing of these fins is important. If they are too near each other, they restrict air flow over the cooler and reduce the efficiency of the cooling system. In stores that will run at temperatures above 4°C a fin spacing of 4 millimeters between fins (six per inch) is acceptable. For store temperatures below 4°C, fins should be spaced at 6 millimeters apart (four per inch) to allow for a certain amount of frosting to occur before air flow is severely restricted. It is important to avoid obstructions before and after the cooling coil as these may cause poor air distribution. The effect of poor distribution is to reduce the effective surface area of the coil resulting in rather lower humidities than were originally intended in the design.

Refrigeration Systems

Stores may be cooled with direct or indirect expansion systems.

Direct expansion. In stores cooled by direct expansion (Figure 52), the evaporator is inside the store and has the dual function of evaporator and cooler. Direct expansion is most commonly used for small and medium sized stores because it is simpler and less expensive than an indirect system.

Usually, a separate condensing unit (compressor and condenser) is provided for each store. In large installations it is possible to arrange for two or three condensing units to supply refrigerant to all storage chambers. Such an arrangement allows flexibility in store management since cooling can be directed to where it is needed.

Indirect expansion. In this system the evaporator is immersed in a secondary cooling medium which is pump circulated through coolers within the stores, the flow to each cooler being automatically controlled by a valve.

An indirect system also gives flexibility since cooling can be directed to where it is needed. There is some insurance against power failure or plant breakdown because the tank of coolant takes a little time to warm up. A further advantage of indirect systems is that they enable more accurate control of cooler temperature than can be obtained with most direct expansion systems.

Figure 52. Refrigeration systems (direct expansion). (From *Control of Air Conditions in Horticultural Stores*, Mechanization Leaflet No.12, Ministry of Agriculture, Fisheries and Food, London).

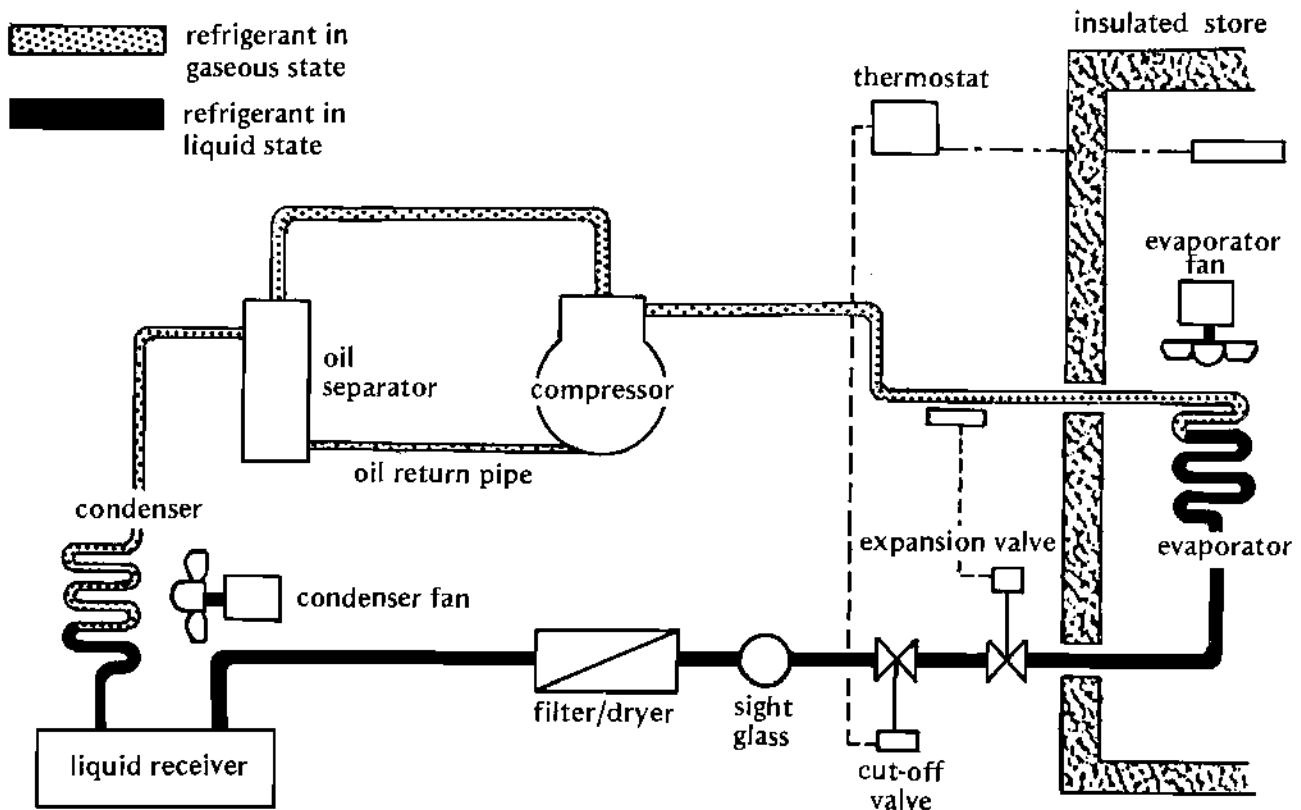

Indirect cooling is only considered economic on large installations (60 kilowatts or more refrigeration requirement) or where very precise control of temperature and humidity is needed.

Control

If the crop temperature is to be controlled with refrigeration throughout the storage period, then with the exception of the initial temperature pull down, this will be done by simple thermostatic control, either by:

- (1) Continuous operation of recirculation fans with thermostatic control of compressor on direct system, or chilled water reservoir and pump on indirect system, or,
- (2) Thermostatic control of compressor or pump together with the fan. By suitably linking the control of refrigeration equipment to the FDV facilities it is possible to operate during the storage season using automatic control with first preference on the main FDV fans for cooling, the refrigeration only becoming operative when cooling is required during unfavorable ambient conditions. This arrangement substantially reduces running costs. The penalty is higher weight loss during FDV periods when the RH percentage is often considerably below the optimum 95 percent obtainable off the coil of a good refrigeration installation.

Recirculation

Recirculation of air in a refrigerated store is essential. To introduce ambient air at possibly 21°C, cool it to 4°C before passing it through the potatoes only to exhaust it several degrees higher is

(Appendix 4, concluded)

extremely wasteful. Recirculation rates over the evaporator coil of a direct refrigeration system or the cooling coil of an indirect system are normally on a per TM stored basis in the range 17 to 35 m³/TM/hr. Any heat exchanger, extracting a given quantity of heat will affect the temperature of that air in direct relation to the volume of air being passed over it.

Recommendations

- (1) Where possible, use Forced Draft Ventilation (FDV) for initial temperature pull down.
- (2) Restrict heat gain to the building by attention to sealing and the provision of an adequate (*U*) value, maximum value of

$$\frac{2.0 \text{ kj}}{\text{hr x m}^2 \text{ x } ^\circ\text{C}}$$

is recommended.

- (3) Unless accurately calculated, assume total heat gains for storage to be 100 to 150 percent of respiration heat load.
- (4) Allow respiration rate of 52 kj/TM/hr.
- (5) Take expert advice on the detailed installation.

Post-harvest Pests, Diseases and Disorders

Appendix 5

Pests

The potato has no exclusive post-harvest pests — all pests causing damage after harvest also infest the growing crop. Post-harvest pest damage itself can be serious plus the fact that damage commonly enhances moisture and disease loss.

The potato tuber moth complex (*Phthorimaea operculella* and related species) is one of the most damaging problems on potato tubers. Larvae damage foliage by mining between the upper and lower epidermis of leaves. Larvae also burrow into tubers making tunnels that become filled with excreta of the pest. Initial tuber infestation occurs in the field but larval feeding continues during storage. An “integrated” approach combining cultural, physical, chemical and biological methods is a promising way of controlling tuber moth. Integrated control, however, requires precise knowledge of the behavioral and developmental biology of the pest under different climatic conditions. Cultural and physical control measures include satisfactory hilling or earthing-up of tubers, irrigation, pre-storage selection, moth proofing of stores and good sanitation. Several chemicals have been successfully used in both pre- and post-harvest treatments although high levels of insect resistance to some chemicals have been encountered. Possible biological controls include use of host resistance, natural parasites, and a synthetic female sex pheromone.

In addition to the tuber moth several other biting and chewing insects cause damage to tubers in both field and storage. These include cutworms, wireworms, millipedes, slugs, and larvae of certain coleoptera, any of which may be locally important.

Nematodes cause tuber damage. The root-knot nematode (*Meloidogyne* spp.) causes galling and deformation of tubers which may also show internal symptoms of nematode feeding. Tuber infection by the potato root or tuber eelworm (*Ditylenchus destructor*) and the stem nematode (*D. dipsacci*) cause darkening of the affected tissues and surface cracking which provide entry for secondary microorganisms. Some species of the lesion nematode (*Pratylenchus* spp.) cause scab lesions, pustules or pimples on tubers. Although the golden or potato cyst nematodes (*Heterodera rostochiensis* and *H. pallida*) do not cause serious tuber damage, infestation of the tuber surface is one of the means of disseminating these important pests.

Aphids, mainly a field problem, can also be important during storage of seed potatoes because of their role in virus spread. Young sprouts are very susceptible to aphid infestation. An uncontrolled infestation can result in spread of leafroll

virus and potato virus Y. Sprouting seed tubers should be examined regularly for aphid infestation and if necessary chemical control measures applied.

In addition to insect and nematode pests, considerable post-harvest losses may result from rodent, bird, and other mammalian pests.

Diseases

Tuber diseases are a common cause of loss in stored potatoes. There is no absolute division of diseases into those which affect the growing crop and those which affect stored tubers, many do both. To assist in selecting appropriate control measures post-harvest or storage diseases may be classified into those in which tuber infection occurs in the field prior to harvesting and those in which tuber infection occurs at or after harvesting. Some tuber diseases result in decay while others cause surface blemishes and/or infection of the tuber eyes. Before disease losses can be reduced the etiology and epidemiology of the specific disease involved must be known.

Diseases causing major decay

Bacterial wilt/brown rot (*Pseudomonas solanacearum*). Field infection of plants occurs through injured roots. Affected plants wilt, turn yellow, and die prematurely. Infection is systemic and spreads to the tubers via the stolons. In early stages the bacteria that cause the disease are confined to vascular tissues. Infected tubers when cut are characterised by a brown vascular ring which, when the tubers are squeezed, exudes a white slimy ooze containing the bacteria. More advanced tuber symptoms are exudation of the ooze around the eyes, to which soil sticks. In severe infections in the field or during storage a more extensive rot of the tuber flesh by secondary invaders may occur, resulting in a liquefaction of tissues and the total collapse of the tubers. Infected tubers are extremely difficult to store but lightly diseased tubers when stored at a low temperature may keep several months. In the case of seed potatoes diseased tubers act as new foci of infection.

The several races and strains of *P. solanacearum* react differently to such factors as temperature, host-range, and host plant resistance. It is essential to know which strain is present. Control of the disease is mainly an integrated approach involving use of more resistant varieties, planting disease free seed, destroying infected plants and tubers and using long crop rotations. Long crop rotations will help reduce the soil-borne inoculum only if alternative host crops and weeds are avoided. Long

rotations are more successful in areas with well defined drought seasons with high temperatures as the bacterium is unable to withstand desiccation. To avoid spreading the bacteria while cutting seed, either avoid this practice or disinfect the cutting knife frequently. Apart from careful pre-storage selection and low temperature storage no post-harvest treatments are available for reducing storage losses.

Blackleg and soft rot (*Erwinia carotovora* var. *atroseptica* and *E. carotovora* var. *carotovora*). Blackleg of the plant usually caused by var. *atroseptica* is a widespread disease. Symptoms include a typical top roll and yellowing of leaves which results in wilt and death. The stem bases develop a black, often slimy lesion, that progresses up the stem and down to the tubers which rot first at the stolon end. The disease is most prevalent in humid climates, both warm and cool.

Tuber soft rot may be produced by both organisms and is one of the most common causes of storage losses. The disease develops from lenticel infection, cracks, surface wounds and bruises and is also found as a secondary disease following other primary diseases and insect damage but later assuming a primary disease role. In storage the soft rotting *Erwinias* are favored most by high temperature, moisture and low oxygen tension or anaerobic conditions. Under these conditions the bacteria can spread from diseased to healthy tubers. In addition to causing severe storage losses the disease may cause seed piece decay following planting and also tuber decay in wet soils. In addition to *Erwinia* spp. several other pectolytic bacteria may be involved in soft rot diseases, such as *Pseudomonas* spp., *Bacillus* spp., *Clostridium* spp., *Aerobacter* spp., and *Flavobacterium* spp. For best control, plant healthy seed, ensure proper tillage and adequate drainage, rogue diseased plants and make good pre-storage tuber selection. Many apparently healthy tubers frequently carry a population of dormant soft rotting organisms which may become active under certain soil and storage conditions. The only safe way to avoid this potential threat is to use seed produced by tuberless planting, using rooted cuttings instead. Soil survival of *Erwinia* spp. is slight. Storage soft rotting may be avoided by storing tubers under dry, cool conditions. Avoid a free water film on tubers, caused either by storing wet tubers or by poor storage conditions resulting in condensation, and the development of anaerobic conditions. Where danger of soft rotting is expected avoid the curing period as conditions which promote curing are also favorable for soft rot development.

Ring rot (*Corynebacterium sepedonicum*) is another extremely damaging seed-borne bacterial disease. Affected tubers have a discolored and decaying vascular ring which can readily provide entry for secondary soft rotting organisms. Bacterial oozing around the eyes as occurs with brown rot does not occur. Infection occurs through use of infected seed, but since the bacterium does not survive in the soil, future crops are not affected. It does, however, survive on tools and sacks in stores

and is readily spread by contaminated cutting knives. Spread may be reduced by strict sanitation practices.

Blight/late blight (*Phytophthora infestans*) in addition to reducing yields by prematurely killing the foliage, also causes tuber rotting in both field and storage. Blight in the field becomes particularly serious at high humidities (heavy dew or rain) at temperatures between 15° and 24° C. Spread to tubers is not by direct internal growth of the fungus, but by spores from infected foliage that fall to the ground and infect growing exposed tubers through the lenticels or eyes. Tubers also frequently become infected at harvest time by being brought into contact with infected foliage. Infected tubers exhibit a brown to purplish discoloration of the skin, spreading inwards to give reddish-brown granular necrotic markings in the tuber flesh. Under good storage conditions this rot will remain dry and there is no evidence to suggest that the disease normally spreads from infected to healthy stored tubers. However, particularly under poor storage conditions, tissue death caused by blight opens the way for secondary soft rotting which can spread within the store. Thus storage losses which may ultimately be traceable to blight are commonly much greater than those caused specifically by blight itself.

Sanitation is important in reducing early season sources of inoculum such as infected seed, previous crop volunteers and cull/waste piles. Resistant cultivars are available although foliage resistance is not always correlated with tuber resistance. Field resistance is more durable than major gene resistance. Organic and metal based fungicides are effective when used as protective sprays at appropriate intervals. To reduce tuber infection, tubers should be well ridged or earthed-up. Allow at least 2 weeks between haulm killing and lifting in blighted crops. Grade-out and destroy blighted tubers prior to storage.

Pink rot (*Phytophthora erythroseptica*) is so named because upon cutting and exposure to air the flesh of infected tubers turns pink and ultimately black. Tubers become infected in the field via the stolon. Excessive soil moisture and hot growing conditions favor the disease. Badly affected tubers develop a rubbery consistency and exude a liquid to which soil adheres. Characteristically they have a smell of vinegar. As with blight, pink rot does not normally spread from infected tubers to cause rotting in previously healthy tubers during storage. Where present in a crop the disease may cause extensive and very rapid break-down of tubers in storage. Although not generally considered of major widespread economic importance, this disease can cause heavy and serious storage losses. If crops are produced on land known to be infected with this organism do not store the potatoes. Where storage is essential, select tubers carefully prior to storage.

Dry rot (*Fusarium* spp.). Many different *Fusarium* spp. have been causally associated with tuber dry rot. Tubers are not normally attacked while still attached to the plant and the majority of infections occur through wounds during harvesting,

grading and other handling operations. Normally the causal agents are incapable of penetrating the tuber through intact skin. Tubers become more susceptible to infection as they mature. Susceptibility increases during storage and symptoms of the disease do not become obvious until several months after harvesting. The skin of diseased tubers typically becomes wrinkled in irregular concentric folds and commonly bears white, pink, red, or bluish pustules of spore-bearing mycelium. The disease is most common following harvesting under warm, very dry conditions, when damage is more prevalent. Disease incidence may be greatly reduced by proper and timely curing. Under warm humid storage conditions secondary soft rots often develop. Severe dry rot in storage indicates that the crop was poorly handled and cured. In addition to causing storage dry rots the same *Fusarium* spp. can cause seed piece decay and wilt. Seed piece decay is frequent when cut, unuberized seed pieces are planted in warm heavily-infested soils. Seed tubers may be protected with chemical sprays or dusts.

Other minor wound and tuber rots include charcoal rot (*Macrophomina phaseoli*), black rot (*Rosellinia* spp.), leak or watery wound rot (*Pythium* spp.), gangrene (*Phoma* spp.), basal stem rot (*Sclerotium rolfsii*) and smut (*Thecaphora solani*). Although considered minor, these diseases can cause severe loss in certain areas. Charcoal rot is most damaging when potatoes mature in hot weather. Gangrene causes serious losses in cold storage in certain cool and wet areas of temperate zones.

Blemish diseases

Common scab (*Streptomyces scabies*) is a prevalent tuber disease in all potato growing regions of the world, except where soils are very acid. Infection results in an unattractive skin condition that reduces market value but which has no effect on flesh quality. Infection occurs initially through young lenticels in the growing tubers and eventually leads to the formation of scabs. The scabs are variable in form but usually are angular and corky, raised or depressed, single or in groups covering the whole tuber surface in which case eyes are also killed. There is no extensive internal tuber damage and scabs do not develop further after harvesting. The disease may be controlled by the use of resistant varieties and its incidence reduced by crop rotation, high soil moisture particularly during early tuber growth and low soil pH (5 to 5.2).

Powdery scab (*Spongospora subterranea*). Tuber infection occurs during the growing season and is favored by cool humid soils. Infection occurs through lenticels and first appears as purplish dots on the surface of young tubers. These spots increase in size, ultimately rupture to liberate masses of spore-balls and leave a characteristically scabby surface. Sometimes small root galls and wart-like tuber cankers are produced. Symptoms do not usually develop further during storage, although some surface necrosis may occur. Chemical seed treatment reduces the infective spore load but will

not eliminate the fungus. Good drainage and long rotation can significantly reduce disease incidence.

Black scurf/stem canker (*Rhizoctonia solani*) is named from the black fungal resting bodies (sclerotia) on the skin of infected tubers. These sclerotia make tubers unsightly although no internal tissue damage results. The fungus may also attack the eyes and young sprouts causing reduced emergence. Stem bases of growing plants may also be infected. In severe cases the stems are girdled by brown lesions and aerial tubers are formed. Also a white mycelial mat may develop on the stem base but this causes virtually no harm to the plant. Chemical treatments of both seed and soil reduce disease incidence. As sclerotia are long-lived in the soil, long rotations with cereals and grasses are recommended to reduce the level of soil inoculum.

Silver scurf (*Helminthosporium solani*) is a common skin blemish that commences as light to dark brown spots on the tuber surface. The blemish may develop and coalesce during storage and cover large areas of the tuber. Infected areas appear silvery and glassy, particularly when wet. In severe conditions destruction of the skin and associated moisture loss affects market and seed quality. The color of red-skinned varieties may be completely destroyed by the disease. High humidity during storage favors disease development. Spread is prevented at storage temperatures below 3°C but losses through dehydration may remain high.

Skin spot (*Oospora pustulans*) when severe may reduce market value of a crop. Sprouting of seed tubers may be prevented if the disease affects the eyes. Symptoms develop gradually during storage and may be confused with non-erupting powdery scab lesions. The condition is commonly aggravated following use of IPC or CIPC sprout inhibitor. Chemical treatment may reduce losses from planting infected seed.

Wart (*Synchytrium endobioticum*) is a destructive disease of the potato. It is characterized by warty outgrowths on all parts of the plant except roots, but principally on tubers and stems. The disease severely reduces yields and tubers are unmarketable. To reduce wart incidence, use long (5 years or more) crop rotations or grow resistant varieties. Quarantine aids in limiting spread of the disease which is essentially through tuber transport.

Several virus diseases cause surface and internal tuber blemishes and cork formation such as tobacco rattle virus, potato mop-top virus and leafroll virus.

Disorders

Several important post-harvest disorders of potato tubers, such as black heart, internal bruising, high and low temperature injury have been discussed previously. Additionally, greening of consumer potatoes can be a problem. Greening, a result of exposure to natural or artificial light, can occur in the field prior to harvest and at any stage during post-harvest handling. Tubers that have turned green taste bitter and may be poisonous due to increased glycoalkaloid content.

Secondary growth of tubers which usually results in some irregularity in tuber shape may cause post-harvest problems. Symptoms of secondary growth include hollow heart, knobliness, chain tuberization, cracking and jelly end rot. Secondary growth is the result of interrupted growth of the tubers, usually due either to high temperatures or drought, followed by abnormal growth after the period of stress. Cracking and jelly end rot, particularly, can enhance soft rotting. Mishapen tubers have a poor market value and frequently result in increased and undesirable quantities of soil being included in storages which adversely affects ventilation and temperature control.

Disinfectants for Stores and Equipment

- Formalin (1:20) used carefully, particularly in closed stores.
- Formalin (1:300) plus sodium hypochlorite (500 - 1,000 ppm) or (1:10%) commercial preparations.
- Where tuber moth has been present, the store and equipment should be fumigated with a locally-available insecticide active against this pest if formalin has not been used.

Chemical Treatment of Tubers:

This depends on the particular pest, disease or disorder which needs to be controlled, on the local availability of pesticides and on prevailing food additive regulations in the case of consumer potatoes. Seek advice of local crop protection specialists.

On-Farm Evaluation of Seed Stores *



Appendix 6

I. INTRODUCTION

In evaluating a seed storage system two phases are involved: (1) storage phase and (2) field production phase.

The field production phase is essential because performance of the stored seed tubers in the field is equally as important as reducing storage losses or increasing storage efficiency.

The evaluation of an "improved" seed storage should be conducted in comparison with the "prevailing" system and will involve the following steps:

- Evaluation and comparison of storage losses under both the "improved" and "prevailing" systems.
- Evaluation and comparison of the field performance of sound tubers from both the "improved" and "prevailing" systems.
- Determination of overall economic efficiency of the "improved" system using a cost-benefit analysis with the "prevailing" system considered as the control.

The final and real evaluation of an "improved" storage system is the degree to which it is adopted. So monitoring the adoption of the "improved" system should be part of the evaluation process. In other words, the agro-economic evaluation should be accompanied by a "farmer evaluation" centered upon his perceptions and opinions of the "improved technology."

II. BACKGROUND CONSIDERATIONS

1. Storage Phase

During this phase both the number and weight of the stored tubers are important. If a farmer is storing seed tubers for his own use the number of plantable tubers coming out of store is more important than their weight. If stored seed tubers are to be sold, the weight of the tubers is of prime importance. Thus during an evaluation, storage losses could be expressed either as the difference in weight or in number between the original quantity stored and the quantity of plantable tubers coming out of the stores.

2. Field Production Phase

The field performance of stored seed tubers can be evaluated using the following factors:

- (a) Emergence, expressed as a percentage of the number of tubers planted.
- (b) Uniformity and speed of emergence.
- (c) Number of stems per plant and per unit area.
- (d) Total quantity harvested per seed quantity planted and per land area planted. In the majority of situations a breakdown of the marketable yield into size categories will also be needed.

3. Economics

The economic evaluation will be based on:

- (a) Difference in storage costs per unit of seed between the "improved" and "prevailing" storage system. This should include differences in both capital and operational costs.
- (b) Value of the losses resulting from both storage systems which will then be considered as part of the total storage costs.
- (c) Value of the production obtained using seed from the two sources.

III. EVALUATION TRIALS

For best results use a multidisciplinary approach involving post-harvest technologies, seed production agronomy and economics.

The following guidelines are for technical evaluations:

1. Storage Phase

Two samples of an equal number (weight) of uniform seed tubers from a single source are weighed (counted). If the two samples are of equal number (weight), their weight (number) should not differ by more than 5% in order to ensure a uniformity in tuber size. The first sample is placed in the "improved" store and the second in the "prevailing" system. Care should be taken to place samples in a representative location within the stores. Both stores should be filled with other tubers to normal capacity.

Normally the two samples will be taken from the farmer's seed lot without any special selection. If additional selection is considered necessary/beneficial then two additional samples of selected tubers are placed in each store type and the cost of this selection (labor and value of rejected tubers) is

* Social Science Department, Training Document 1980-7, International Potato Center, Apartado 5969, Lima, Peru, pp 10.

taken into account during the final economic analysis.

During the storage phase seed placed in the "prevailing" system is managed according to the farmer's normal practice. Any additional managerial operations conducted as part of the "improved" system, for example, the application of insecticides or removal of apical sprouts, are costed and added to the storage costs of that system.

Where possible, record ambient maximum and minimum temperatures both outside and inside the stores.

At the end of the storage period the plantable tubers are selected, counted and weighed and the storage losses based on weight and number determined. If at this stage desprouting is practiced it is done prior to the determination of losses. The weight of the desprouted sprouts is included with that of the discarded tubers.

2. Field Production Phase

The two remaining samples of plantable tubers are planted and cultivated in two adjacent plots using the farmers normal cultivation practices from planting through harvest. The area (or the total length of rows) planted with each sample is determined. If the topography of the field makes it necessary, the samples should be divided and planted in sub-plots using, for example, a Latin square design.

The percentage of emergence in each plot is determined on three occasions (by counting the number of emerged plants and expressing this as percentage of the number planted). The specific dates for determining the percentage of emergence should be fixed according to local experience. These recordings are made at regular intervals commencing shortly after first emergence and continuing until full emergence.

In cases where large numbers of tubers are planted, the determination of percentage emergence may be done in a sub-plot staked within the field and in which a known number of tubers were planted (one hundred, for example).

IV. SUMMARY OF DATA TO BE RECORDED

1. Storage Phase

History of stored seed, variety and harvest date.

Remarks on general condition of tubers.

Number and weight of the tuber samples.

Tuber selection criteria — farmer or improved.

Percentage tubers discarded during selection.

Date of initiation of storage period.

Observations on storage systems; for example, size, capacity, construction.

Details of store management practices.

Ambient and store maximum and minimum temperatures.

Date of removal from the stores.

Number and weight of plantable tubers per sample.

Percentage total storage losses per sample and where possible this should be divided into disease, sprouting and dehydration losses.

Observations on condition of the tubers and sprouts (for example, record the average length of sprouts and average number of sprouts per tuber on a sub-sample of tubers from each store).

Economic data as detailed in paragraph V below.

2. Field Production Phase

Planting date.

Number of tubers planted.

Planted areas.

Percentage emergence on three fixed occasions.

Average number of stems per plant using a sub-sample of 50 to 100 plants per plot.

Total quantities harvested (per plot and subsequently per plant) and their breakdown into marketable yield by different size grades where necessary.

Observations on cultural/harvest practices, for example, planting methods, fertilization, irrigation, crop protection practices, incidence of pests, diseases and weeds, harvesting methods.

Economic data as detailed in paragraph V below.

V. ECONOMIC EVALUATION

1. Background Considerations

a. Storage Losses Coefficient.

For each sample included in the trial we know: the quantity stored (q_1) (weight or number) and the plantable quantity coming out of the store (q_2). The storage losses coefficient (ℓ) is defined as:

$$\ell = \frac{q_1 - q_2}{q_1}$$

thus we can determine " ℓ " for the improved store (ℓ_i) and for the prevailing store (ℓ_f).

b. Storage Costs.

Investment Costs. The evaluation of these costs is based on determination of *changes in expenditure* incurred while changing from the prevailing store to the improved one.

Some of these changes may consist of new investments (construction of new facilities or modification of existing ones, including interest). These investments, "I", will contribute to the storage cost of one unit of seed stored by:

$$S_1 = \frac{I}{Q \times n}$$

where "Q" is the capacity of the store and "n" is the number of storage seasons over which the investment should be recovered (depreciation). It is obvious that the S_1 calculated applies only to the improved store.

In cases where the prevailing system consists of rented cold store space then the cost of the prevailing storage system must include the rental cost "R" per unit of seed.

Operational Costs. Operational costs will vary between the two systems (e.g. electricity for ventilating or illuminating the improved store, less handling operations in the improved store, repairs) and will therefore need to be calculated for each system. Say: O_i for the improved one and O_f for the prevailing one.

Thus the storage cost per unit of seed will be:

$$S_i = \frac{I}{Q \times n} + O_i \text{ for the improved system, and}$$

$$S_f = R + O_f \text{ for the prevailing system.}$$

c. Value of the Seed at Planting Time

If P_s is the value of a unit of seed entering the stores, then the value of a unit of seed coming out from the improved store is:

$$P_{si} = \frac{P_s + S_i}{1 - \ell_i}$$

the prevailing store is:

$$P_{sf} = \frac{P_s + S_f}{1 - \ell_f}$$

2. Partial Budget Analysis Per Unit Area Planted with the Stored Seed

Let: q be the quantity of seed planted/unit area,
 y_i the yield per unit area of the crop planted with the improved store seed,
 y_f the yield per unit area of the crop planted with the prevailing store seed,
 P_c the price of consumer potatoes at harvest time.

Change in Cost. The cost of planting one unit area with the improved store seed will be:

$$C_i = q \times P_{si}$$

for the prevailing store seed it will be:

$$C_f = q \times P_{sf}$$

The change in cost incurred while changing from the prevailing system to the improved one will be:

$$\Delta C = C_i - C_f = q (P_{si} - P_{sf})$$

Change in Total Income. Incurred while changing from the prevailing system to the improved one will be:

$$\Delta TI = P_c (y_i - y_f)$$

If the price of consumer potato varies with its grade then the ΔTI should be calculated accordingly.

3. The Economic Evaluation

This evaluation will help answer these following two questions:

(1) Is the improved system economically better than prevailing one? To answer this positively the change in net income (ΔNI) due to the use of the improved system should be positive:

$$\Delta NI > 0 \text{ where } \Delta NI = \Delta TI - \Delta C$$

(2) How much better? The net benefit/cost ratio will help answer this question.

It is expressed by:

$$\text{Net benefit cost ratio} = \frac{\Delta NI}{\Delta C}$$

This ratio reflects the rate of return on additional money spent when adopting the improved system.

Since farmers who adopt a new technology are taking a risk, it might be wise to consider that a benefit/cost ratio of at least one is needed to indicate a potential of adoption.

Note: In cases where the seed is stored for sale the decision rule should be the following:

The improved system is better if the value of the change in storage losses covers the change in cost due to the adoption of the improved storage system. This can be expressed by:

$$P_m (\ell_f - \ell_i) > S_i - S_f$$

where P_m is the market price for the seed, the other symbols being the same as above.

VI. EXAMPLE

Evaluation of a newly constructed diffuse light store v/s the farmer's system (bulk, dark). \$ is the monetary unit of the country. The symbols used are the same as above.

1. Storage Costs

Construction Cost of the New Store

Item	Cost (\$)
Plastic sheets	204
Wood	405
Plastic mesh	75
Nails	10
Labor	50
Total Investment * (I)	744 \$

Capacity of the Store (Q): 3000 kg

Depreciation over 5 years with 1 storage period of 5 - 6 month/year:

$$n = 5$$

Operational Costs Improved Store (O_i):

During storage an insecticide is used (carbaryl-powder 5%) at the rate of 5 kg per ton Price 3 \$/kg

$$O_i = \frac{3 \times 5}{1000} = 0.015 \text{ $/kg}$$

* Normally a financial cost (interest) is added to the investment. Its estimation is done according to local financial procedures.

Operational Cost of Farmer's Store (O_f)

During storage 2 selections/desprouting are needed. Two man days at 2\$ each are needed for handling, selecting and desprouting 1 ton of potatoes.

$$O_f = \frac{2 \times 2 \times 2}{1000} = 0.008 \text{ \$/kg}$$

Storage Cost of Improved Store (S_i)

$$S_i = \frac{744}{3000 \times 5} + 0.015 = 0.065 \text{ \$/kg}$$

Storage Cost of Farmer's Store (S_f)

$$S_f = O_f = 0.008 \text{ \$/kg}$$

2. Storage Losses

The farmer is storing seed for his own use. The storage trial is thus based on the number of tubers stored. The weight is shown in () where necessary.

	Improved Store	Farmer's Store
Original sample (q_1)	1000 tubers (97 kg)	1000 tubers (95 kg)
Plantable quantity (q_2) . .	910 tubers (83 kg)	840 tubers (70 kg)
Losses ($q_1 - q_2$)	90 tubers (14 kg)	160 tubers (25 kg)
Losses coefficient (ℓ)	0.09 tubers (0.14)	0.16 tubers (0.26)

3. Value of Seed at Planting Time

The value of 10 tubers of seed (1 kg approximately) entering the store is $p_s = 0.20$ \$. Thus the value of 10 tubers of seed coming out from the improved store is:

$$p_{si} = \frac{0.20 + 0.065}{1 - 0.09} = 0.29 \text{ \$}$$

the farmer's store is:

$$p_{sf} = \frac{0.20 + 0.008}{1 - 0.16} = 0.25 \text{ \$}$$

4. Field Results

The samples are planted in 50 hill rows (95 x 40 cm).

18 rows (342 m²) are planted with the improved store seed.

16 rows (304 m²) are planted with the farmer's store seed.

Note: In order to avoid having incomplete rows 10 tubers (1.0 kg) from the improved store seed and 40 tubers (3.0 kg) from the farmer's store seed have not been included in the trial. The agronomical results are summarized in the following table:

	Improved Store Seed	Farmer's Store Seed
Number of tubers planted	900 . . .	800
Weight of tubers planted (kg)	82 . . .	71
Area planted (m ²)	342 . . .	304
% of emergence at 20 days	35 . . .	5
% of emergence at 30 days	89 . . .	60
% of emergence at 40 days	94 . . .	91
Ave No. of stems/plant	3.4 . .	2.9
Yield of the plot (kg)	582 . . .	453
% of 1st size grade potatoes	28 . . .	32
% of 2nd size grade potatoes	42 . . .	40
% of 3rd size grade potatoes	30 . . .	28
Average yield per tuber planted (gr)	647 . . .	566
Plant density/ha (q)	26000 . . .	26000
Estimated yield (t/ha)	16.8 . .	14.7

5. Partial Budget for 1 ha

Change in Cost

$$\Delta C = q (p_{si} - p_{sf}) = 26000 \left(\frac{0.29 - 0.25}{10} \right) = 104 \text{ \$}$$

Change in Total Income

If the price of consumer potato is:

- 0.20 \$ for the first grade potatoes
- 0.17 \$ for the 2nd grade potatoes
- 0.10 \$ for the 3rd grade potatoes

Then the total revenue for 1 ha:

- planted with improved store seed will be: 2644\$
- planted with farmer's store seed will be: 2352 \$ and:

$$\Delta TI = 2644 - 2352 = 292 \text{ \$}$$

The Change in Net Income will be

$$\Delta NI = \Delta TI - \Delta C = 292 - 104 = 188 \text{ \$}$$

The Net Benefit Cost Ratio will be

$$\frac{\Delta NI}{\Delta C} = \frac{188}{104} = 1.81$$

6. Case of Seed Stored for Sale

The analysis should be done using the values of (ℓ) calculated on the basis of weight, figures in () in paragraph II.

we have:

$$\ell_i = 0.14 \quad \ell_f = 0.26$$

if the market price for the seed is 0.28 \$/kg then,

$$p_m (\ell_f - \ell_i) = 0.28 (0.26 - 0.14) = 0.03$$

we already know the values of S_i and S_f then,

$$S_i - S_f = 0.065 - 0.008 = 0.057$$

Thus we see that in this example the improved system is not profitable for a seed merchant, assuming that the seed from the two sources has the same price on the market.

As an exercise, the reader could calculate the change in net income and the net benefit cost ratio for one ton of seed stored for sale.

We found: $\Delta NI = -23 \$$

$$\frac{\Delta NI}{\Delta C} = -0.40$$

This publication was processed and printed in
the Training and Communications Department,
International Potato Center,
Apartado 1558,
Lima, Peru.

October 1981

IX-Ph-E-23-0-2200